

## **CBD Chemical Production Building Virginia, USA**



## Executive Summary

The following technical report analyzes the existing conditions and structural design of CBD Chemical's Production Building located in Virginia. This building is a five story, 55,000 GSF chemical production building with a mezzanine on the first floor, main production floor, and penthouse roof. The analysis of the structural systems included verifying the loads used by the structural engineers on the project and spot checking various beams and columns.

Using ASCE7-10 to determine the loads on the Production Building, it was determined that earthquake loads control for both base shear in the North-South direction and overturning moment in both directions, while the wind loads control the base shear in East-West direction. The controlling base shear calculated is 516.7 kips in the North-South direction and 514.4 kips in the East-West. The controlling overturning moment was calculated to be 37282.3 kip-ft.

Select spot checks were performed in the Production Building to determine the efficiency of the existing structural system. Checks were done for the floor system, a composite beam, and a girder on the third floor. Both the floor and beam were found to have a lot of extra capacity. The floor was designed as a 5.5 inch slab and the decking and two inches of concrete in the decking were not accounted for and considered to be arbitrary. The beam was designed as a non-composite beam but built as a composite beam, meaning it has more capacity than needed. In contrast, the girder was found to be adequate. Two columns were checked, one interior and one exterior. Both were found to be acceptable.

The lateral system of the Production Building was analyzed using ETABS. Only the lateral frames were inputted into the computer model. The story drifts, load distribution and building torsion were all calculated and analyzed. The building has torsional irregularity which leads to two floors exceeding the  $h/400$  drift limit often used by engineers. However, due to the metal panels used in the building enclosure a large drift will not cause problems to the façade. In addition, two columns were spot checked in the lateral system. Both were found to be adequate to carry the loads they are exposed to.

Three alternate gravity floor systems were designed and compared to the existing non-composite system. A composite beam system, a two-way flat slab system, and a one-way concrete slab system were designed and analyzed to determine if they were viable floor systems for the Production Building. It was discovered that the two-way flat slab system was not a good solution, while the one-way concrete, composite and non-composite systems were all found to be worth further exploration.

# Table of Contents

1.0 Introduction .....	1
2.0 General Structural Information.....	1
Foundation System .....	2
Floor System .....	2
Framing System.....	2
Lateral System.....	4
3.0 Determination of Loads .....	5
3.1 Gravity Loads.....	5
3.2 Wind Loads.....	8
3.3 Seismic Loads .....	11
3.4 Blast Loads .....	13
4.0 Evaluation of Systems .....	14
4.1 Floor System for Typical Bay.....	16
4.2 Typical Beam and Girder Check .....	16
4.3 Typical Column Check .....	19
4.4 Lateral Systems .....	20
4.4.1 Load Cases/Combinations.....	22
4.4.2 Load Distribution.....	22
4.4.3 Lateral Analysis .....	26
4.4.5 Lateral Member Spot Checks .....	27
4.5 Alternate Floor Systems.....	<b>Error! Bookmark not defined.</b>
4.5.1 Non-composite Beam (Existing System) .....	<b>Error! Bookmark not defined.</b>
4.5.2 Composite Beam .....	<b>Error! Bookmark not defined.</b>
4.5.3 Flat Slab.....	<b>Error! Bookmark not defined.</b>
4.5.4 One-Way Slab.....	<b>Error! Bookmark not defined.</b>
4.5.5 Comparisons between Systems .....	<b>Error! Bookmark not defined.</b>
5.0 Conclusions .....	28

6.0 Appendices.....	34
Appendix A: Framing Plans .....	34
Appendix B: Equipment Loads per Floor .....	39
Appendix C: Snow Load Calculations .....	41
Appendix D: Wind Load Calculations .....	43
Appendix E: Seismic Load Calculations .....	47
Appendix F: Floor Spot Check Calculations.....	49
Appendix G: Beam and Girder Spot Check Calculations .....	50
Appendix H: Column Spot Check Calculation: Gravity System .....	53
Appendix I: Non-Composite Steel System (Existing).....	58
Appendix J: Composite Steel System .....	61
Appendix K: Two-Way Flat Slab .....	64
Appendix L: One-Way Concrete Slab .....	69
Appendix M: Load Distribution Calculations.....	71
Appendix N: Column Spot Check Calculations: Lateral System .....	73

## 1.0 Introduction

The purpose of this report is to analyze the existing conditions and explore other viable solutions to the design constraints for The Production Building in Virginia, USA. All of the structural loads on The Production Building were calculated, including dead, live, snow, wind, seismic and blast. The existing structure was analyzed and compared to four other systems to determine feasibility.

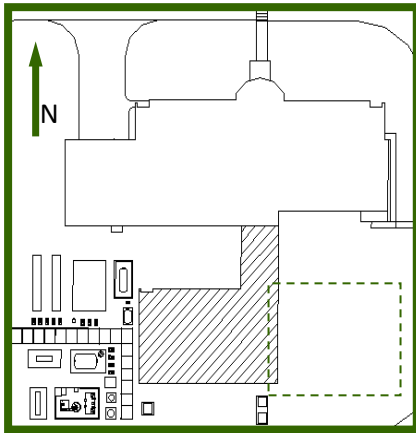

*Figure 1.1: Site Plan.* Courtesy of Project Engineer. This plan shows a portion of the campus footprint with the Production Building shaded. The future bays will be located in the dashed area.

The Production Building is an addition to an existing campus with laboratory and chemical manufacturing spaces owned by CBD Chemical\*. CBD Chemical has occupied the site since 1991 and produces drug substances and intermediates for the pharmaceutical industry. Each facility on site is an FDA inspected cGMP facility. This five-story, \$125 Million, 55000 GSF addition includes a penthouse roof as well as a mezzanine level above the first floor. This addition also connects to the existing building at the first floor level. Figure 1 shows the footprint of the existing building campus, the current Production Building addition (shaded area), and the future production building to be built (dashed area). The space was designed to easily expand farther east. Construction started in April 2008 and was completed in January 2009. This project was design-bid-build with a Negotiated Guaranteed Max Contract.

The majority of the chemical production equipment will be located on the first floor, although much of the facility will house additional production spaces, laboratory spaces, and production support. The existing two story building houses the majority of office space; however, the second floor of the new production building incorporates some additional office space.

The Production Building is composed of a steel frame structure with concrete on metal deck for the floor systems. The exterior skin is a combination of insulated metal panels and translucent wall panels. Due to the highly explosive material within, many of the walls must be blast resistant. Some of the factory-insulated metal wall panel systems serve as the explosion release wall assemblies. Each floor has explosion release wall assembly panels as well as translucent pressure venting assembly panels. The north and south facing walls have horizontal strips of windows, while the West end has a vertical strip of windows. The roof is comprised of concrete on metal deck, rigid insulation and an EPDM waterproof membrane covering.



*Figure 1.2: Isometric View.* (Courtesy of Project Architect) The Production Building is the five-story building in the back.

\*Name changed for confidentiality

## 2.0 General Structural Information

The structural system for the Production Building is moment frame structural steel. The first floor has an 8 inch slab on grade while the other four floors have normal weight concrete on metal deck. The Production Building was designed to IBC 2003, and used ASCE 7-02 and the AISC Steel Manual 3<sup>rd</sup> edition LRFD; however for the purposes of this report, it will be checked against the most recent ASCE 7-10 and 14<sup>th</sup> edition of the AISC Steel Manual.

### Foundation System

The Production Building was built on site class E soils as noted in the geotechnical report.

The foundation system for CBD Chemical's Production Building is precast concrete piles 12 inch x12 inch that are 80 ft long. Each pile had to be driven to an elevation of 20 feet. On top of the concrete piles are spread footings with piers that extend up to the concrete tie beams that span between each column. Figure 2.1 to the right shows a typical pile cap detail.

Each of the precast concrete piles has 28-day strength of 6000psi and has a 100-ton capacity. The spread footings and strip footings used concrete with 28-day strength of 4000psi. On the first floor, the slab on grade is an 8 inch cast-in-place concrete slab. All rebar is grade 60.

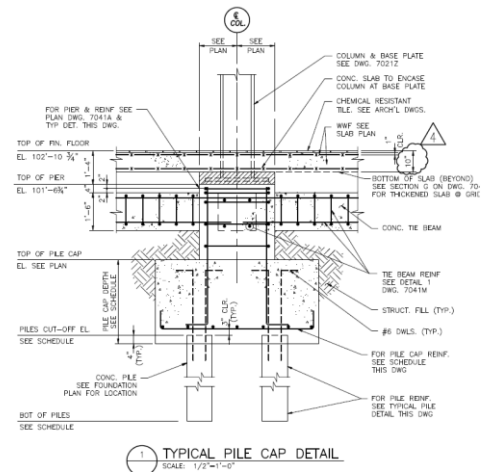

Figure 2.1: Typical Pile Cap Detail. Courtesy of Project Engineer.

### Floor System

The floor system is comprised of 7½ inch normal weight concrete on a 2VLI 18 gage composite deck. This forms a one-way slab system running in the east-west direction. The deck must use the three-span condition unless framing does not permit. On the mezzanine level, 1¼ inch steel grating was used.

### Framing System

The framing system is composed of W24s for the girders and exterior beams. W12s are used as infill support underneath equipment. Figure 2.2 is the third floor framing plan. In the figure the different spans and infill beams are shown, as well as the equipment framing for the large equipment. The 12 foot girders span the bay from which the pipe racks hang. These are framed with W12s. The beams are framed 3 equal spaces of 6 feet 3 inches, 3 equal spaces of 6 feet 8 inches and 5 equal spaces of 6 feet for the 12 feet 6 inches, 20 feet, and 30 feet East-West bays respectively. The beams included in the lateral system are larger than the infill beams between column lines. However, in locations underneath large equipment loads, the infill beams were increased. In addition, the second floor and fourth floor have equipment built in. Thus, some of the beams had to be spaced slightly differently at those locations. In this case, more framing was necessary to hold the equipment in place. There are W12s framing in between the beams in the East-West direction. The mezzanine level is only special framing to accommodate specific equipment. This framing uses W8s, W10s, and W16s and frames into select

columns on the first floor level. The pipe racks on each floor hang from the floor structure above, also utilizing W6s and W8s. Every beam on every floor has 3/4 inch diameter steel studs spaced at one foot on center. Each beam works compositely with the slab above. The columns are W14s and are spliced every 2 floors. The floors have large floor to floor heights of 24 feet for the first floor and 18 for subsequent floors. This is because vessels, equipment, and the W24beams and girders must fit above the ceilings. See Appendix A for the additional framing plans. Each floor is slightly altered from the typical framing system in at least one location.

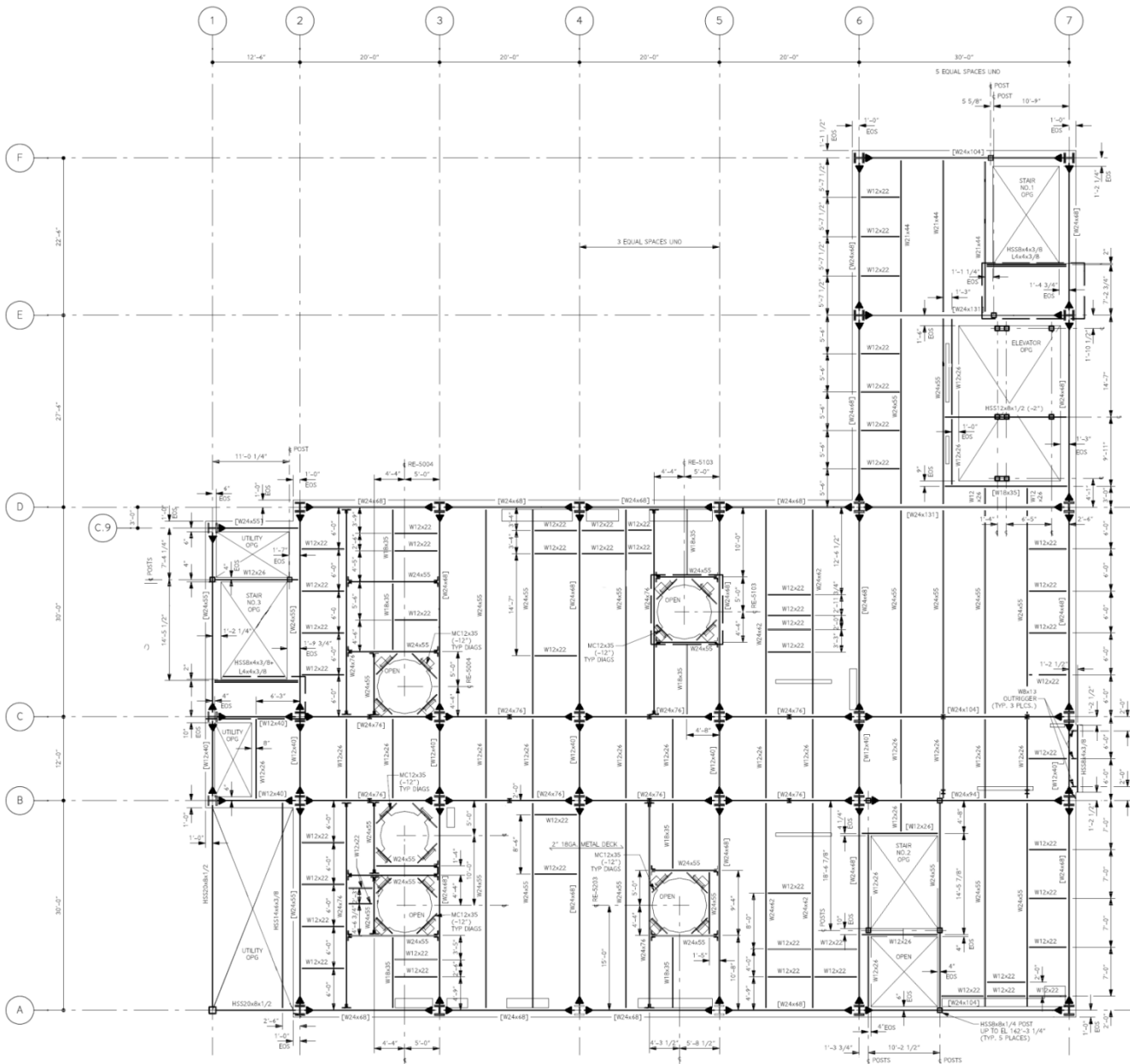

Figure 2.2: Courtesy of Project Engineer. The third floor framing plan.

## Lateral System

The lateral system for the Production Building is comprised of steel moment frame connections. Each column has moment connections in both the North-South and East-West directions. Due to CBD Chemical's requests for the Production Building, there was very little room to fit any other kind of lateral system. There simply was no room for any shear walls or even bracing. Due to this constraint, the engineers had still needed extra capacity in the lateral system and needed to turn the columns on the West end 90° so the strong axis was along the East-West direction. The out of the ordinary column placement is highlighted in Figure 2.2. The mezzanine does not contribute to the lateral system.

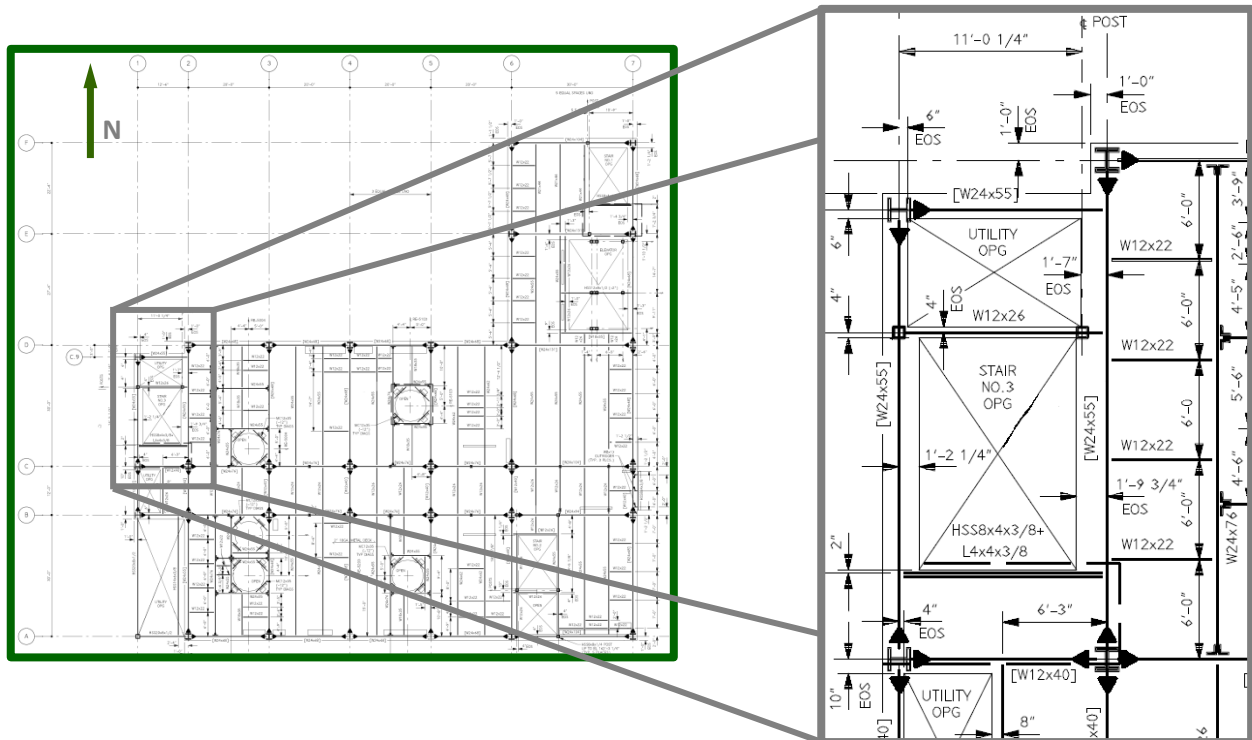

Figure 2.3: Courtesy of Project Engineer. The third floor framing plan showing the odd column rotation on the west end of the building.

With this lateral system any horizontal loads will be caught by the insulated metal panel system. The explosive pressure release panels are tied to the building frame through the use of HSS tubes which then transfer load to the slab system. The slab system works as a rigid diaphragm due to the large amount of concrete from which it is comprised. From the slab system the load is transferred to the foundation through the beams, then to the girders, and lastly to the columns, which sit on pads sitting on concrete piles.



## 3.0 Determination of Loads

### 3.1 Gravity Loads

#### 3.1.1 Dead and Live Loads

The dead loads used for the Production Building are relatively high due to the heavy equipment supported on each floor. The live loads plus superimposed dead loads on the second through fifth floor of the production building include the live load of 200 psf and the equipment pads, steel framing, MEP, and partitions, totaling 298 psf. The steel framing seems high at first glance but due to the framing in the pipe rack and around equipment there are many beams in a relatively small area in many parts of the building. Also, because the Production Building is for the pharmaceutical industry most of the rooms are clean rooms. Therefore there will be many partitions between clean room production areas and the equipment. There are equipment loads on each of these floors. The slab was increased to a 7½ inch depth (larger than specified in the deck manual) on 2VLI composite deck. The slab was designed as a 5½ inch concrete slab. The additional two inches of concrete in the deck and the decking itself were considered arbitrary and were not designed to contribute to the strength of the system. A summary of dead loads is included below, as well as a table of the equipment point loads per floor. For the purposes of this report equipment will be considered dead load. Most of this equipment is built into the framing or bolted to the equipment pads. Therefore, it will act as dead load on the structure for the majority of the building life. The only equipment loads listed in table 3.2 are those that exceed the live loads per floor. Please see Appendix B for the location of the equipment point loads on the floor plans per floor.

First Floor Dead Load	
Equipment Pad (NWC)	100 psf
Total	100 psf
Second through fifth floor Dead Load	
7½" slab on 2VLI 18 ga Deck (NWC)	82 psf
Equipment Pads (NWC)	50 psf
Steel Framing	18 psf
MEP	20 psf
Partitions	10 psf
Total	180 psf
Penthouse Roof Dead Load	
6" slab on 2VLI 18 ga Deck (NWC)	63 psf
Equipment Pads (NWC)	50 psf
Steel Framing	18 psf
MEP	20 psf
Roofing	4 psf
Misc Dead	5 psf
Total	160 psf

Table 3.1: Dead Loads

Equipment Loads per Floor											
First Floor		Second Floor		Third Floor		Fourth Floor		Fifth Floor		Roof Level	
No.	Operational Weight	No.	Operational Weight	No.	Operational Weight	No.	Operational Weight	No.	Operational Weight	No.	Operational Weight
1	47 k	1	31 k	1	44 k	1	44 k	1	11 k	1	20 k
2	56 k	2	31 k	2	40 k	2	25 k	2	3 k	2	102 k
3	50 k	3	27 k	3	36 k	3	23 k	3	6 k	3	126 k
4	25 k	4	27 k	4	51 k	4	23 k	4	2 k	4	26 k
5	58 k			5	21 k	5	51 k	5	2 k	5	11 k
6	36 k			6	23 k	6	44 k				
				7	11 k	7	21 k				
						8	29 k				

*Table 3.2:* Equipment dead loads per floors. The only equipment loads listed are those that exceed the live loads per floor. Appendix B shows the layout of the equipment for design purposes (not the equipment layout plan).

### 3.1.2 Snow Loads

The ground snow loads for Virginia, USA are 25 psf. The pressure on the flat roof without drift was calculated to be 19.3 psf. Because there is a penthouse, drift loads had to be considered as well as just snow loads. The penthouse is 15 feet by 50 feet and is located above the elevator and stairs on the Northeast corner of the Production Building. The drift on the penthouse was calculated to be 39.7psf. The drift was also accounted for on the 4 foot 6 inch parapets on the building. The parapet condition produced the highest drift weight of 48.3 psf. The figure below shows the loading produced by the snow load and drift against the penthouse. This figure is not drawn to scale. For the full calculations for snow loads please see Appendix C.

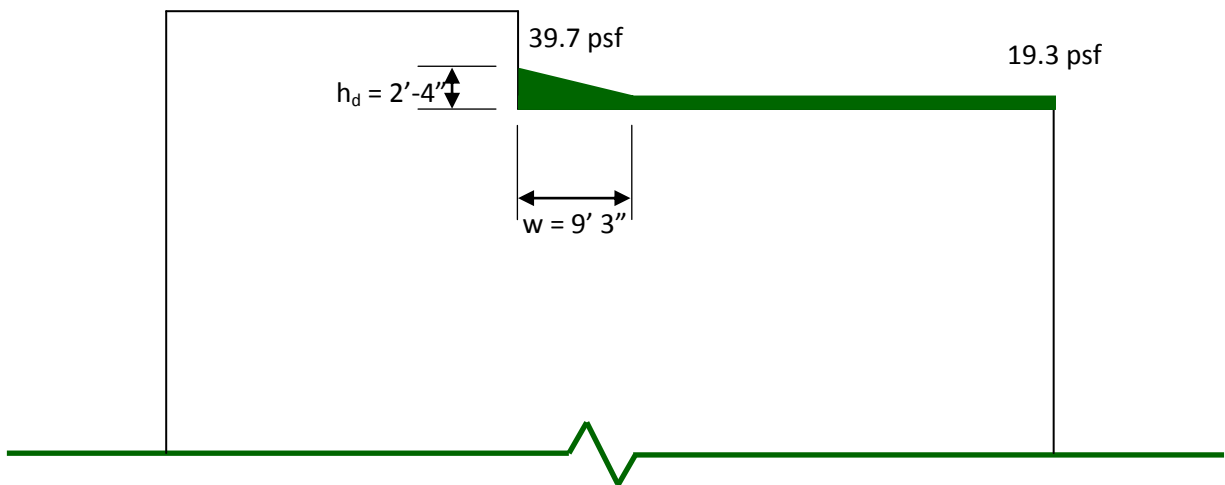
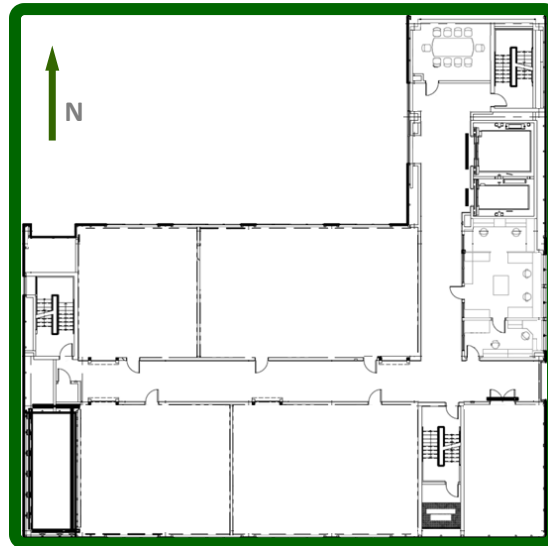

Figure 3.1: Snow load and drift up to the penthouse.

### 3.2 Wind Loads

To determine the wind pressures on the Production Building, ASCE 7-10 was used. Both the North-South and East-West directions were analyzed. To calculate the pressures, the penthouse was assumed to act as an extension of the building due to the columns continuing up through the penthouse level without splices beyond the fifth floor.



*Figure 3.2:* Courtesy of Project Engineer. Layout of the building footprint. The building is 122 feet by 122.5 feet.

The building footprint is 122 feet by 122.5 feet. Therefore the base shears and overturning moments are not much different for the two directions. The Production Building is located in an area with very little surrounding it; therefore the exposure is Exposure C. This was confirmed with the engineers involved. Throughout the entire site the elevation remains constant. Therefore, the  $K_{zt}$  factor is 1.0. In tables 3.5 and 3.6 below the East-West and North-South wind pressures and forces were calculated as well as the base shear and overturning moment each way. Neither of these base shears or overturning moments control over the earthquake loading. Figures 3.4 and 3.5 below show the pressures acting on the Production Building. For full wind calculations please see Appendix D.

East - West Wind				
Floor	$h_i$	$z$	Windward Force (k)	Leeward Force (k)
1	0	0	29.5	-28.4
2	24	24	54.0	-49.7
3	18	42	51.8	-42.6
4	18	60	56.8	-42.6
5	18	78	60.7	-42.6
Roof	18	96	58.4	-39.1
PH Roof	15	111	11.1	-7.3
			$\Sigma = 292.7$	$\Sigma = -224.0$
Base Shear = 516.7 k				
Overturning Moment = 29832.2 k-ft				

Table 3.4: East-West wind loading.

North-South Wind				
Floor	$h_i$	$z$	Windward Force (k)	Leeward Force (k)
1	0	0	29.6	-28.5
2	24	24	54.2	-49.9
3	18	42	52.0	-42.8
4	18	60	57.0	-42.8
5	18	78	60.9	-42.8
ROOF	18	96	58.6	-39.2
PH Roof	15	111	3.3	-2.2
			$\Sigma = 286.1$	$\Sigma = -219.8$
Base Shear = 505.9 k				
Overturning Moment = 29954.5 k-ft				

Table 3.5: North-South wind loading.

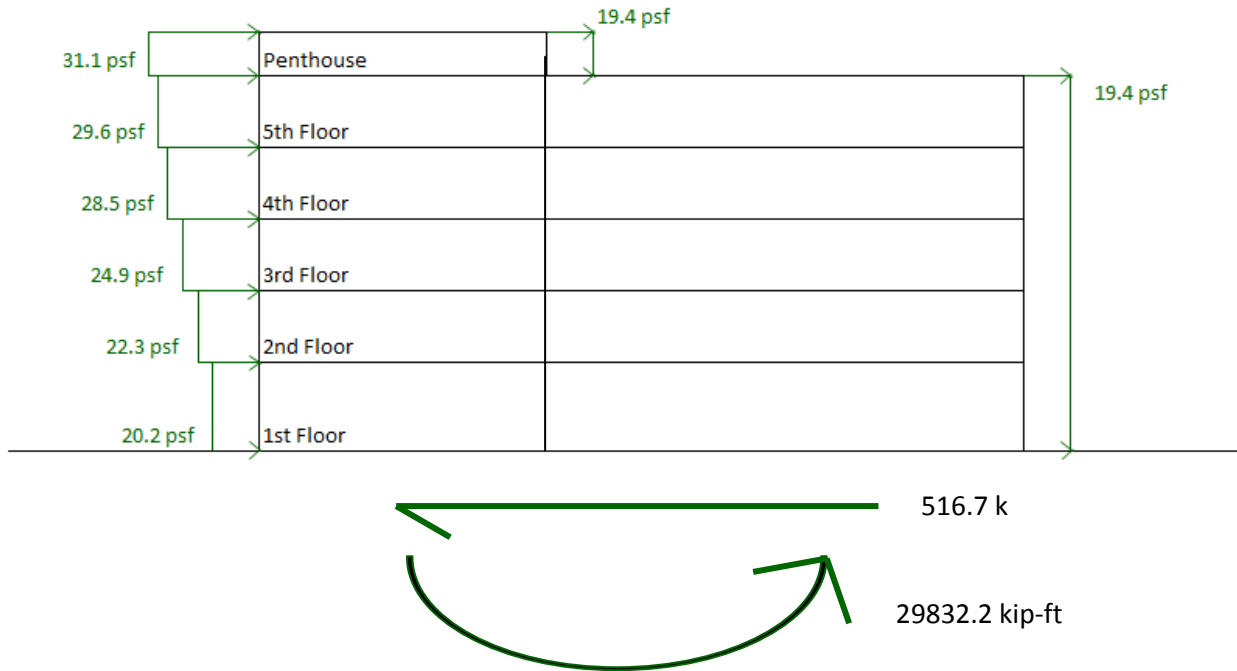

Figure 3.3: The pressure distribution, base shear and overturning moment for the East-West wind load case.

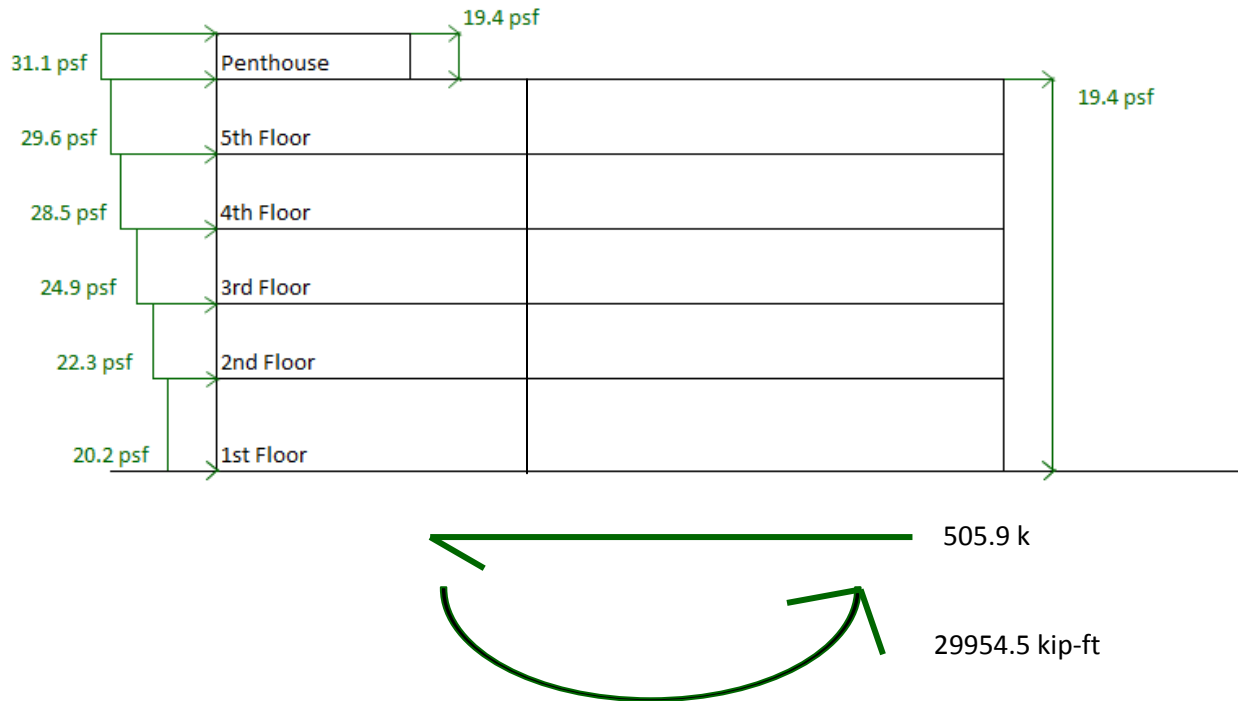

Figure 3.4: The pressure distribution, base shear and overturning moment for the North-South wind load case.

### 3.3 Seismic Loads

To calculate the seismic loads for the Production Building, ASCE 7-10 was used. The geotechnical report classified the site soils as site class E. Because a more recent code was used to check, some of the seismic response coefficients are slightly different from the designers. Using the USGS website to pinpoint the seismic region,  $S_{DS} = .26g$  and  $S_{D1} = .138g$  were calculated by inputting the address of the site and performing subsequent calculations. The seismic data may have changed from ASCE 7-02 to ASCE 7-10. The designers for the Production Building calculated  $SDS = .40g$  and  $SD1 = .18g$ . These two numbers do not match, however the USGS website has been updated since the building was designed in 2002. Design category C was the more conservative site classification. This category was confirmed by the structural engineers of the Production Building.

To calculate the building weights, the equipment loads should be considered dead load. Most of the equipment will be bolted to the equipment pads or framed into the floor itself. Therefore, for the purposes of earthquake engineering these loads will be adding to the mass of the building that will increase the base shear and moment to be resisted. For this reason, when calculating the floor weights of each level, the equipment point loads per floor were added as dead load. The dead loads used were the same calculated in section 3.1.1. For the penthouse roof level 8 psf was used for framing, 5 psf for roofing/insulation, 2 psf for roof deck, and 5 psf for miscellaneous dead load. In addition the exterior wall weight was added to each floor. For the full weight calculations please see Appendix E. The following table shows the floor weights calculated.

Floor	Total Weight (k)
1	2572
2	2103
3	2293
4	2283
5	2025
ROOF	1981
Penthouse	19

*Table 3.6:* These are the total dead loads per floor used in the seismic procedure.

The earthquake base shear and overturning moment controlled over wind. The base shear to resist seismic loads was 514.4 kips, while the overturning moment was 37,214 ft-kips. The figure below shows the load on each floor as well as the base shear and overturning moment for the earthquake loading. Please see Appendix E for complete calculations and tables.

Floor	Total Weight (k)	z (ft)	$w_x h_x^k$	$C_{vx}$	$F_x$ (k)
1	2572	0	0	0	0
2	2103	24	126874	0.06	30.5
3	2293	42	284658	0.13	68.4
4	2283	60	449002	0.21	107.9
5	2025	78	558657	0.26	134.2
ROOF	1981	96	714527	0.33	171.6
Penthouse	18.6	106	7624	0.00	1.8
$\Sigma =$			2141342	1.0	514.4
Overturning Moment =					37214

Table 3.7: The table used to calculate story forces and overturning moment.

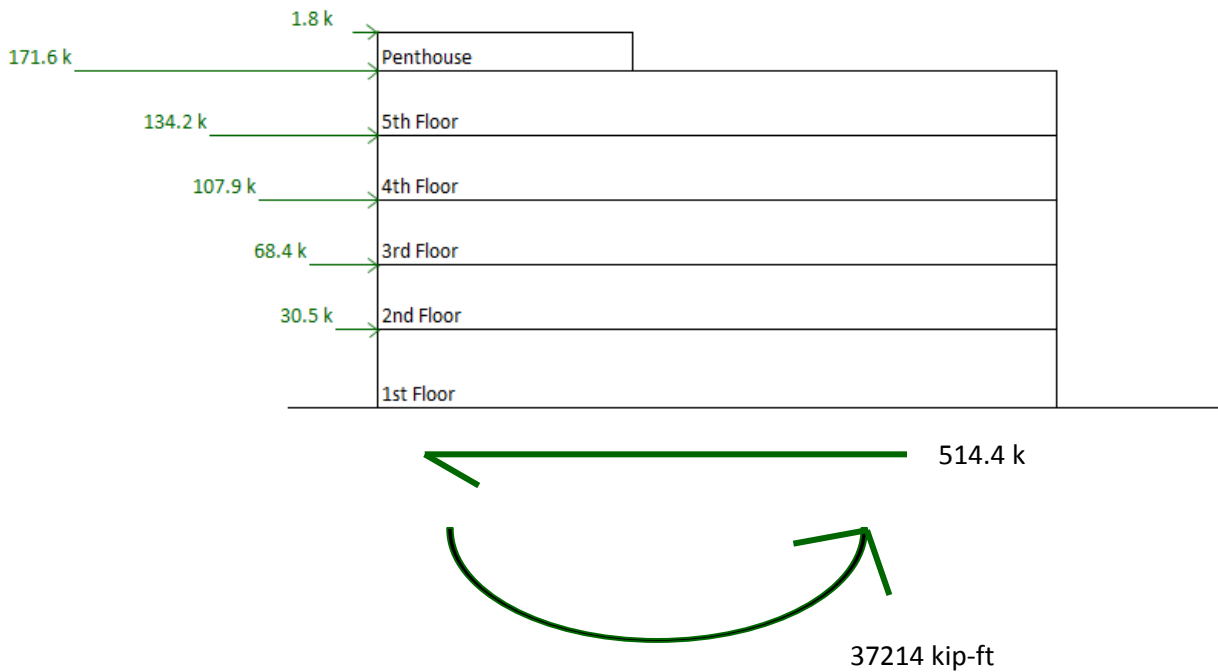

Figure 3.5: The seismic story forces, base shear and overturning moment.



### ***3.4 Blast Loads***

Due to the close regulation of their systems, CBD Chemical determined that 40psf would be the over pressure that could be caused by an explosion. The engineers used this overpressure to design their blast resistant system. Rather than designing the building to stand with parts of the structural system removed to account for an explosion, the walls were designed to fail first. At 40psf the connections of the fabricated panels will fail causing the panels to fall out onto the ground below.

## 4.0 Evaluation of Systems

Spot checks were performed on a beam, girder, and two columns (one exterior and one interior). The figures below show the area of the building chosen to complete these spot checks. The green box outlines the bay and the gray boxes show exactly which beam, girder, and columns were spot checked. Complete spot check calculations can be found in appendix F.

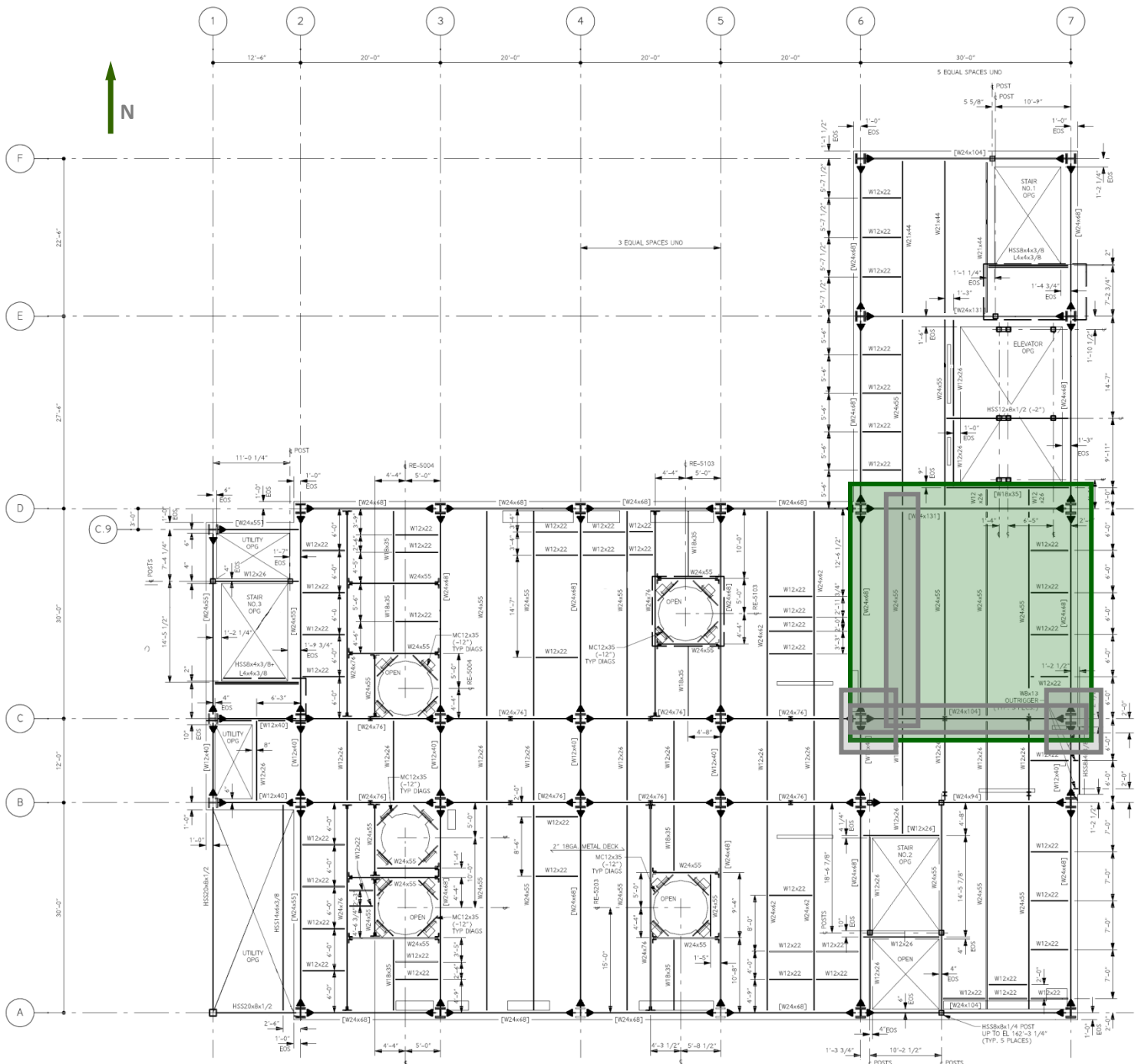

Figure 4.1: Courtesy of Project Engineer. The third floor plan with the green box locates the area where spot checks will be performed. The gray boxes outline which beam, girder and columns were spot checked.

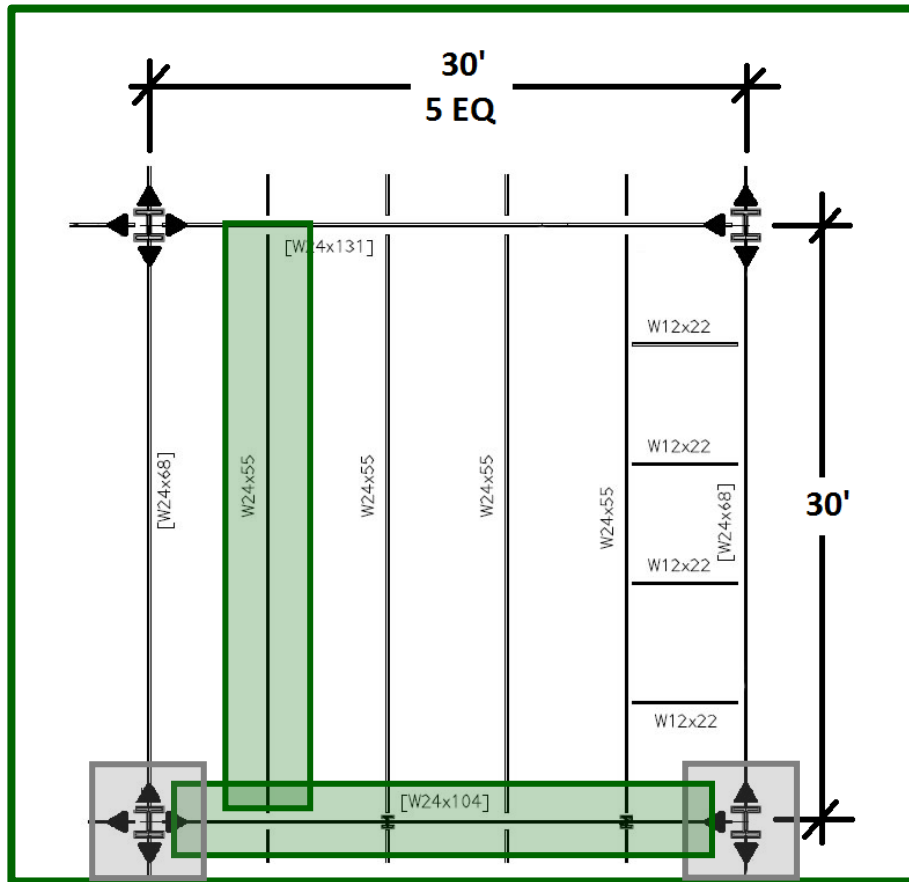

Figure 4.2: A framing plan of the third floor 30 foot by 30 foot bay all of the spot checks will be in. The green boxes show which beam and girder analyzed. The gray boxes show the two columns analyzed.

## 4.1 Floor System for Typical Bay

The floor check will be performed on the third floor. The area in question is within the green box in Figure 4.1 above. The dead and live loads calculated in section 3.1.1 and 3.1.2 were used. The drawings specify 2VLI 18 gage deck with 7 ½ inches of normal weight concrete. This specification with 7 ½ inches of normal weight concrete is not listed in the Vulcraft Steel Deck catalog. However, the table states that for any loads above 200 the manufacturer must be contacted due to the majority of those cases resulting from high point loads. The designers however designed the slab as a 5 ½ inch slab and considered the deck and concrete underneath arbitrary. The full calculations for the decking spot check can be found in Appendix F.

## 4.2 Typical Beam and Girder Check

### 4.2.1 Beam Check

Figure 4.3 below shows the beam that was analyzed in the typical beam check. The structural cover sheet notes that every beam shown in the plans should have ¾ inch shear studs spaced every foot on center. Calculating the capacity of the beam that was spot checked revealed that much of the capacity of the composite beam is not needed. Because it actually acts as a composite beam, the capacity was calculated to be 910 kip-ft even though the load it needs to hold is only 361.8 kip-ft.

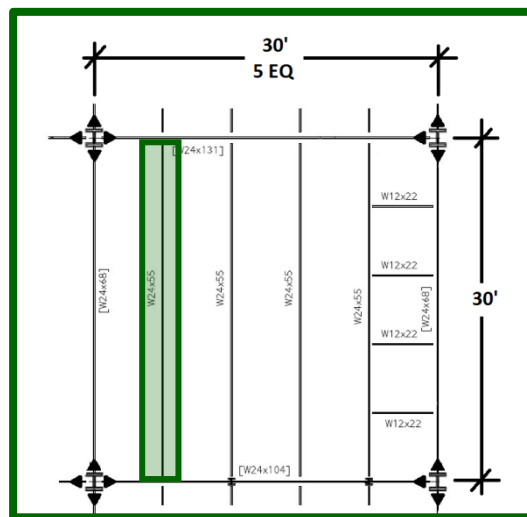

Figure 4.3: Floor plan courtesy of Project Engineer. The bay chosen to spot check. The beam being checked is highlighted in green.

Comparing these calculations with the engineer's calculations, it was discovered that the beam was never designed as a composite beam. Figure 4.4 shows the output of the designer's final RAM model. The value shown for  $\Phi M_n$  is equal to 502.5 kip-ft which is the capacity of the W24x55 without acting compositely. Comparing the engineers  $M_u$  to the output  $\Phi M_n$  the beam is still only using 72% of its

capacity. This is probably to accommodate for future use of the space. CBD Chemicals would eventually like to expand and therefore the engineers were mindful to design the building for enough capacity that it would still hold if production were increased. For complete calculations and a suggested beam calculation please see Appendix G.

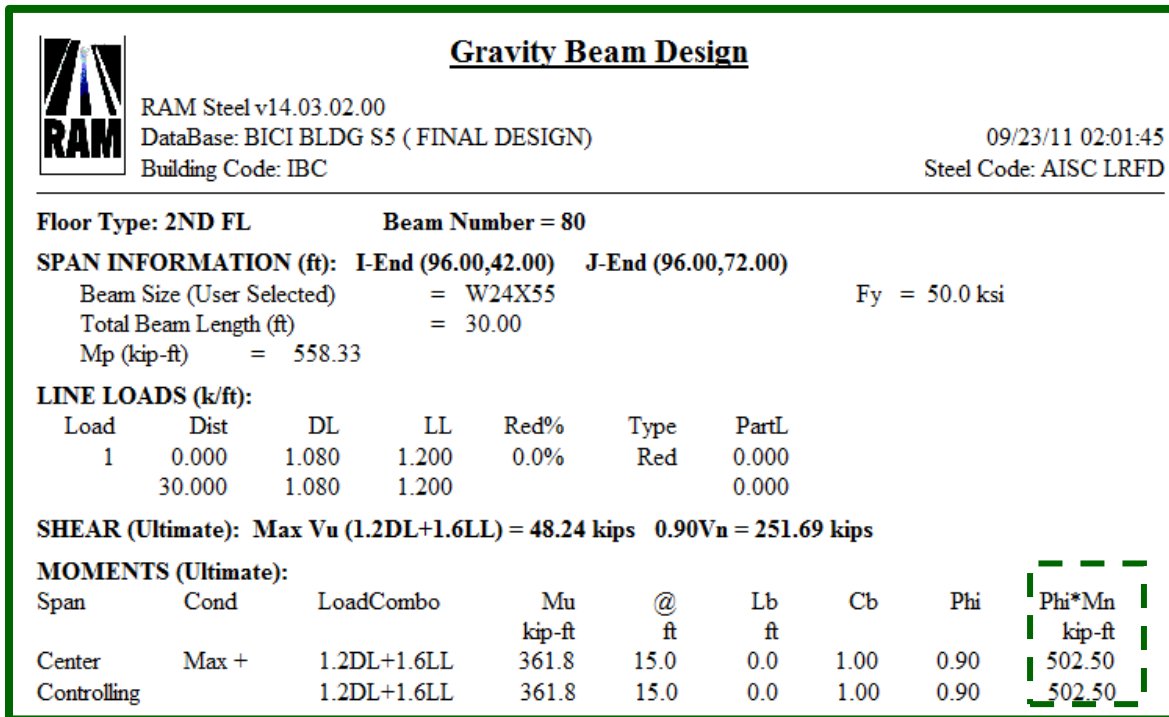
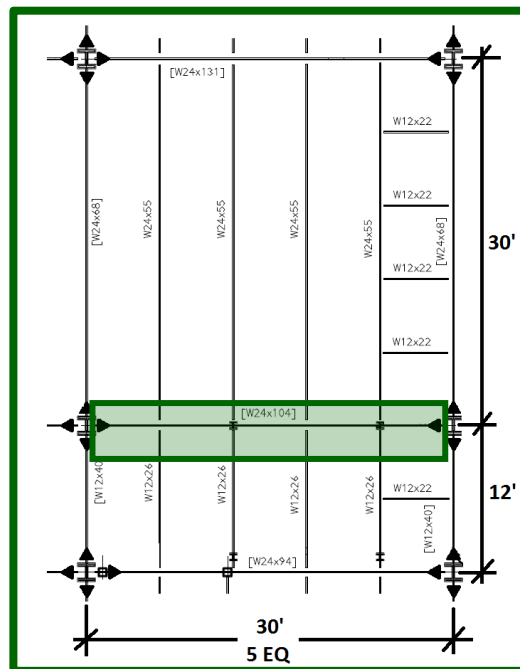

Figure 4.4: Courtesy of Project Engineer. The output from the engineers' calculations in RAM. The dashed line shows that the capacity of the beam is the non-composite capacity of a W24x55 rather than the composite action of the constructed beam.

## 4.2.2 Girder Check

Because this girder is part of the lateral system it is connected to both columns with moment connections. To simplify calculations, fixed beam coefficients from ACI continuous beam moment coefficients used. Because the bay sizes are different, the average bay length was calculated and used in the tables. The W24x55 on the right end of this bay has W12x22 beams framing every 6 feet. These beams are already accounted for in the steel allowance. The controlling moment was calculated as -561.9. Because this largest moment is negative, the beam will not work compositely. A W21x68 was determined to be the most economical. The larger beam chosen by the designer is due to the lateral analysis. Each girder is part of the lateral system and therefore could have more moment when the lateral loads are applied. The designer chose a W24 for the ease of the connection with the W24 beams that would be framing into the girder. For complete calculations please see Appendix G.



*Figure 4.5:* Floor plan courtesy of Project Engineer. The bay chosen to spot check. The girder checked is highlighted in green.

### 4.3 Typical Column Check

For capacity of the columns, the 14th edition of the AISC Steel Manual was used to calculate the interaction between the bending and axial loading of the column. The figure 4.6 below represents the columns checked. Using pattern loading, the unbalanced moments were calculated for each floor level, and then added together down the length of the column. The columns in the Production building are only spliced once in the third floor level. At this splice the column size changes from W14x370 to W14x176. Also these columns are only braced at the floor levels. Since the greatest loading on these columns will be at the base right before the splice, only two checks per column had to be performed. Using combined loading the interaction for the first floor interior column was found to be .95. The interior 3rd floor column interaction was .64. The interactions for the exterior columns were calculated to be .86 and .57 for the first floor and third floor respectively. These numbers seem correct as the wind and earthquake loading will increase the moment in the columns. Although the first floor columns seem to be loaded close to capacity, the earthquake and wind loading would increase the moment at the base by a smaller percentage than the top. The W14x370s used on the first floor are mostly controlled by the Pu not the Mu. Please see appendix H for full calculations and tables.

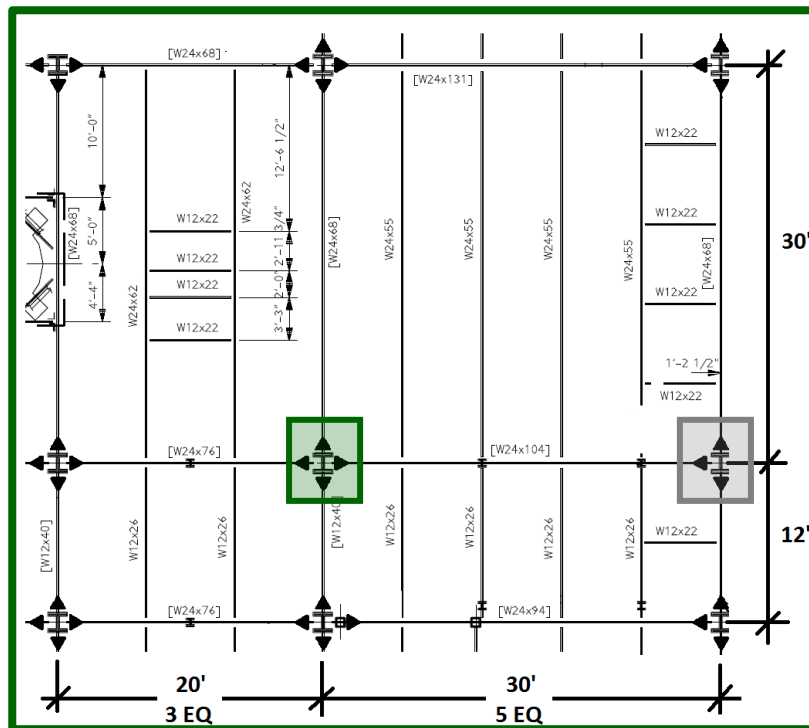
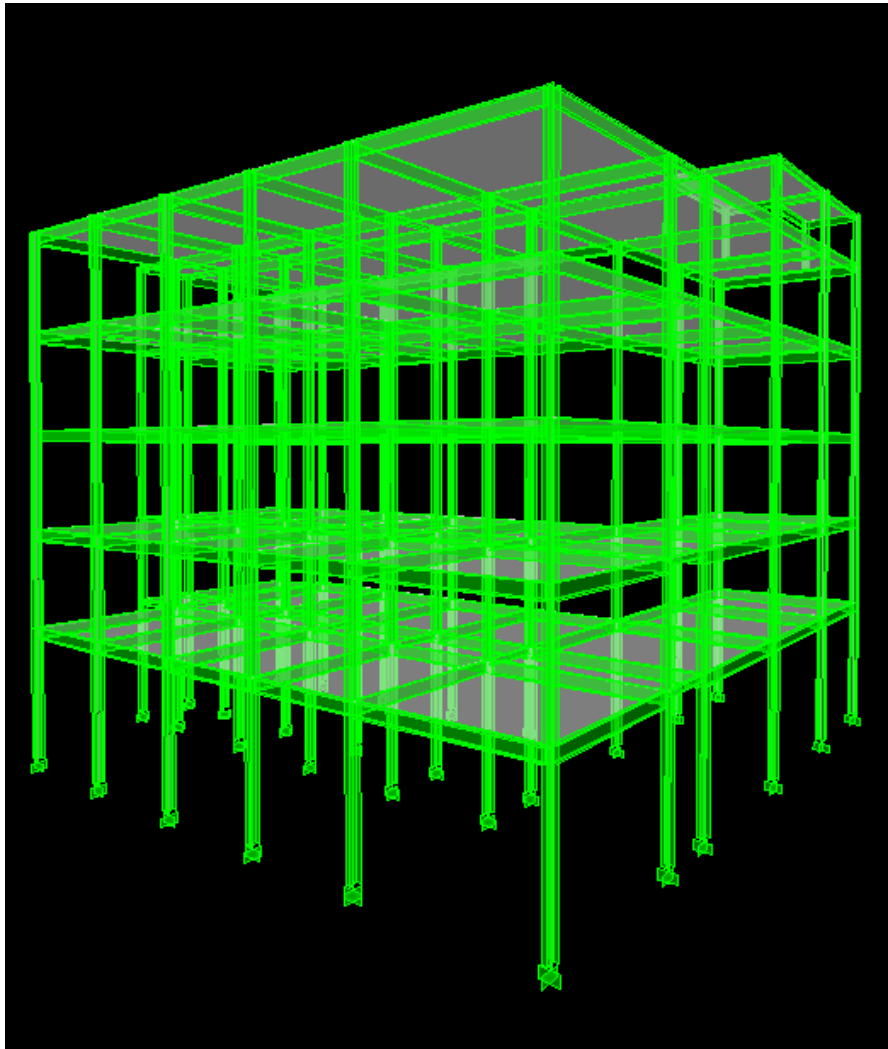

Figure 4.6: Floor plan courtesy of Project Engineer. The bay chosen to spot check. The interior column checked is highlighted in green. The exterior column checked is highlighted in grey.

## 4.4 Lateral Systems

To evaluate the lateral system in the Production Building a computer model was built and analyzed in ETABS. This model was used to determine drifts, forces and moments in the lateral system. Figure 4.7 shows an extruded view of the model built. Only the lateral members were included in the model although there is only one column that is not part of the moment frames.

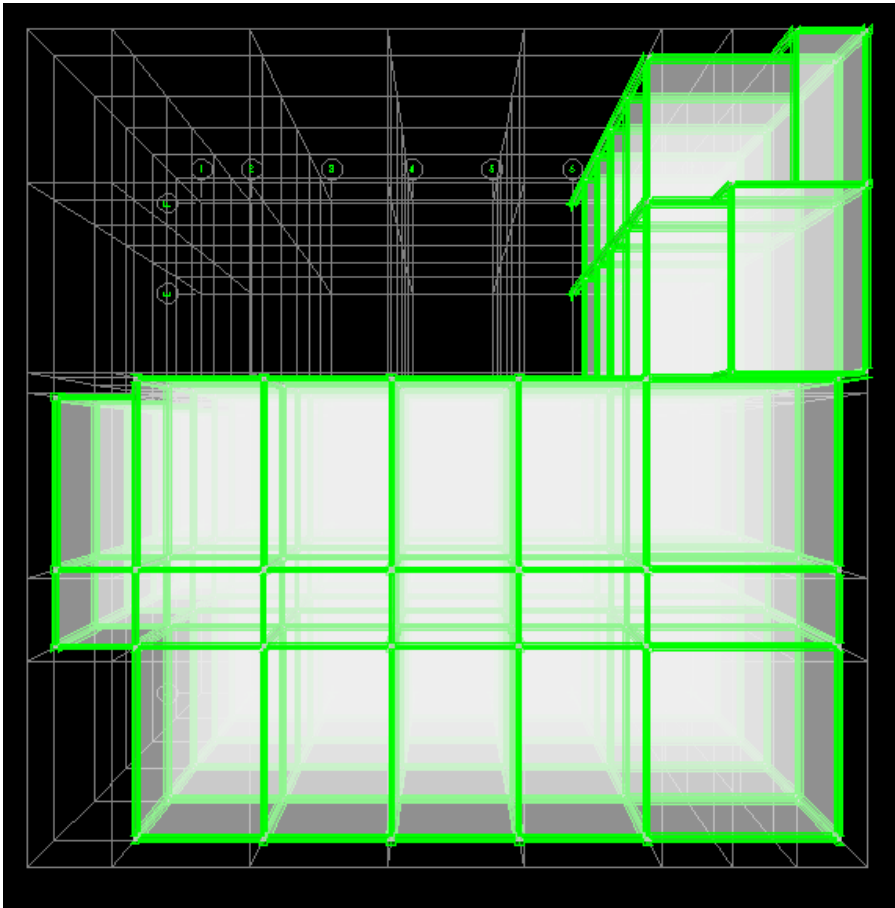

*Figure 4.7:* A 3D extruded view of the ETABS model used to analyze the lateral system.

Due to the concrete floor system built a rigid diaphragm was assumed. The southwest corner of the building contains the only gravity column in the building which supports a mechanical shaft that does not contribute to the horizontal diaphragm at any floor. The bases were all modeled as fixed columns to correspond with the built design. The equipment loads on each floor were added to the entire weight of the floor and applied at the center of mass for that floor. The mezzanine level was neglected as it does



not greatly impact the global lateral system of the building. Lastly, careful consideration was taken to ensure each girder and column was defined correctly as many of the sizes do not repeat throughout the building and were modeled with centerline modeling. Figure 4.8 shows a bird's eye view.



*Figure 4.8:* A bird's eye view of floor diaphragms and moment frames modeled in the ETABS model used to analyze the lateral system.

#### 4.4.1 Load Cases/Combinations

Load combinations used for this analysis are from ASCE 7-10. These combinations have changed from the previous edition of ASCE 7-05. Due to the 1.0 factor on both wind and earthquake these loads are not directly comparable. The seven load cases from ASCE 7-10 that are applicable are

1.  $1.4D$
2.  $1.2D + 1.6L + 0.5Lr$
3.  $1.2D + 1.6Lr + 0.5W$
4.  $1.2D + 1.0W + 1.0L + 0.5Lr$
5.  $1.2D + 1.0E + 1.0L$
6.  $.9D + 1.0W$
7.  $.9D + 1.0E$

Each of these load combinations were considered when performing spot checks. Different load cases govern at different locations making each one important to consider. However, only the earthquake and wind loads were analyze directly in ETABS due to not modeling the gravity members. The dead loads were of course used when calculating the masses to perform a dynamic analysis.

#### 4.4.2 Load Distribution

The lateral resistance system in the Production Building is moment frames. In order to calculate relative stiffness of each frame, a 1 kip load was applied at the center of rigidity. The relative stiffness is then calculated by determining the load that is distributed to each frame because load follows stiffness. The center of rigidity was calculated from the relative stiffness. Figure 4.9 shows the moment frames labeled as they were analyzed.

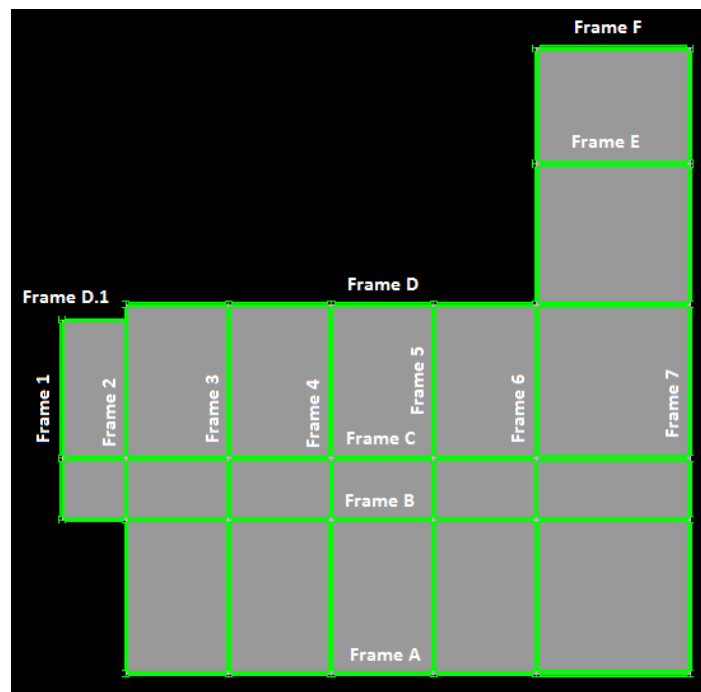

Figure 4.9: The frames labeled in the ETABS model.

Because the center of mass and center of rigidity are at different locations, the building experiences torsion. This torsion was taken into account when calculating the loads in each frame for wind and seismic in both the N-S and E-W. Only the direct wind and seismic were calculated. Table 4.1 shows the frame relative stiffness in each direction.

Frame Relative Stiffness			
North-South Direction		East-West Direction	
Frame 1	3	Frame A	17.6
Frame 2	12.08	Frame B	20.0
Frame 3	14.29	Frame C	20.9
Frame 4	14.38	Frame D.1	2.7
Frame 5	14.47	Frame D	17.8
Frame 6	20.8	Frame E	11.0
Frame 7	21	Frame F	10.1
$\Sigma=$	100.0 %	$\Sigma=$	100.1 %

*Table 4.1:* Relative stiffness in the North-South and East-West directions.

The Production Building has torsion. The center of mass and center of rotation are 1.4 feet apart in the x-direction and 2.3 feet apart in the y-direction. The center of pressure and center of rotation are even further apart, 8.5 feet in the x-direction and 8.1 feet in the y-direction. Figure 4.10 shows the inherent torsion of the Production Building. Because of this inherent torsion the incidental torsion had to be applied both in negative moment and positive moment depending on which section of the building being analyzed. For hand calculations only direct forces were used. Tables 4.2 display load path distribution for the direct north and east wind cases and direct earthquake cases. Please see Appendix M for full calculations.

WIND N/S Load Distribution					
Frame	$e_x$ (ft)	P (k)	Direct Shear (k)	Torsional Shear (k)	Total Shear (k)
Frame 1	8.5	516.7	15.5	27.4	42.9
Frame 2	8.5	516.7	62.4	90.4	152.8
Frame 3	8.5	516.7	73.8	61.4	135.3
Frame 4	8.5	516.7	74.3	31.6	105.9
Frame 5	8.5	516.7	74.8	-6.5	68.3
Frame 6	8.5	516.7	107.5	-64.4	43.1
Frame 7	8.5	516.7	108.5	-148.3	-39.8
Frame A	8.5	516.7	0	122.7	122.7
Frame B	8.5	516.7	0	60.0	60.0
Frame C	8.5	516.7	0	29.5	29.5
Frame D.1	8.5	516.7	0	-5.9	-5.9
Frame D	8.5	516.7	0	-45.4	-45.4
Frame E	8.5	516.7	0	-68.0	-68.0
Frame F	8.5	516.7	0	-92.6	-92.6

Table 4.2a: Direct wind distribution analysis for the North-South direction.

WIND E/W Load Distribution					
Frame	$e_y$ (ft)	P (k)	Direct Shear (k)	Torsional Shear (k)	Total Shear (k)
Frame 1	8.1	505.9	0	25.5	25.5
Frame 2	8.1	505.9	0	84.2	84.2
Frame 3	8.1	505.9	0	57.2	57.2
Frame 4	8.1	505.9	0	29.4	29.4
Frame 5	8.1	505.9	0	-6.1	-6.1
Frame 6	8.1	505.9	0	-59.9	-59.9
Frame 7	8.1	505.9	0	-138.1	-138.1
Frame A	8.1	505.9	89.0	114.2	203.3
Frame B	8.1	505.9	101.1	55.9	157.0
Frame C	8.1	505.9	105.5	27.5	133.0
Frame D.1	8.1	505.9	13.8	-5.5	8.3
Frame D	8.1	505.9	90.1	-42.3	47.7
Frame E	8.1	505.9	55.6	-63.3	-7.7
Frame F	8.1	505.9	51.1	-86.2	-35.1

Table 4.2b: Direct wind distribution analysis for the East-West direction.

SEISMIC N/S Load Distribution					
Frame	$e_x$ (ft)	P (k)	Direct Shear (k)	Torsional Shear (k)	Total Shear (k)
Frame 1	1.4	514.4	15.4	4.5	19.9
Frame 2	1.4	514.4	62.1	14.8	76.9
Frame 3	1.4	514.4	73.5	10.0	83.5
Frame 4	1.4	514.4	74.0	5.2	79.1
Frame 5	1.4	514.4	74.4	-1.1	73.4
Frame 6	1.4	514.4	107.0	-10.5	96.5
Frame 7	1.4	514.4	108.0	-24.2	83.8
Frame A	1.4	514.4	0	20.0	20.0
Frame B	1.4	514.4	0	9.8	9.8
Frame C	1.4	514.4	0	4.8	4.8
Frame D.1	1.4	514.4	0	-1.0	-1.0
Frame D	1.4	514.4	0	-7.4	-7.4
Frame E	1.4	514.4	0	-11.1	-11.1
Frame F	1.4	514.4	0	-15.1	-15.1

Table 4.2c: Direct earthquake distribution analysis for the North-South direction.

SEISMIC E/W Load Distribution					
Frame	$e_y$ (ft)	P (k)	Direct Shear (k)	Torsional Shear (k)	Total Shear (k)
Frame 1	2.3	514.4	0	7.3	7.3
Frame 2	2.3	514.4	0	24.2	24.2
Frame 3	2.3	514.4	0	16.5	16.5
Frame 4	2.3	514.4	0	8.5	8.5
Frame 5	2.3	514.4	0	-1.7	-1.7
Frame 6	2.3	514.4	0	-17.3	-17.3
Frame 7	2.3	514.4	0	-39.8	-39.8
Frame A	2.3	514.4	90.5	32.9	123.4
Frame B	2.3	514.4	102.8	16.1	118.9
Frame C	2.3	514.4	107.3	7.9	115.2
Frame D.1	2.3	514.4	14.0	-1.6	12.4
Frame D	2.3	514.4	91.6	-12.2	79.4
Frame E	2.3	514.4	56.5	-18.2	38.3
Frame F	2.3	514.4	52.0	-24.8	27.1

Table 4.2d: Direct earthquake distribution analysis for the East-West direction.

### 4.4.3 Lateral Analysis

#### Drift Analysis

Most of the drifts of the Production Building under wind and seismic loads are acceptable. The maximum drifts were calculated in ETABS for both wind and earthquake in the North-South (Y) and East-West (X) directions. The wind story drifts were compared to  $h/400$  which although not required by code is commonly used. Due to  $h/400$  being a serviceability check the unfactored wind drifts were used. Story drifts under earthquake loads had to be compared to  $.015h$  for category III buildings. The drifts for wind and earthquake are shown in table 4.1 below. The drifts are compared to their limits in table 4.3.

Drift (in.)													
Floor	Height (ft)	WIND ANALYSIS						EARTHQUAKE ANALYSIS					
		WIND - E/W		WIND - N/S		Allow	Pass?	EQ - E/W		EQ - N/S		Allow	Pass?
		x-dir	y-dir	x-dir	y-dir			x-dir	y-dir	x-dir	y-dir		
Penthouse	15	0.09	0.04	0.07	0.06	0.45	YES	0.20	0.04	0.04	0.24	2.7	YES
Story 5	18	0.17	0.14	0.14	0.14	0.54	YES	0.74	0.04	0.14	0.87	3.24	YES
Story 4	18	0.29	0.25	0.25	0.25	0.54	YES	1.26	0.07	0.24	1.43	3.24	YES
Story 3	18	0.41	0.36	0.35	0.37	0.54	YES	1.66	0.09	0.30	1.89	3.24	YES
Story 2	18	0.40	0.37	0.35	0.39	0.54	YES	1.46	0.11	0.27	1.74	3.24	YES
Story 1	24	0.39	0.28	0.33	0.31	0.72	YES	1.35	0.01	0.22	1.30	4.32	YES

Table 4.3: Actual drifts of the building compared to allowable drifts for both wind and earthquake

#### Overtuning

The controlling overturning moment was calculated in section 3.3 seismic calculation. Seismic controls both in the North-South and East-West directions. Figure 4.11 is a copy of the same image from that section showing the earthquake overturning moment.

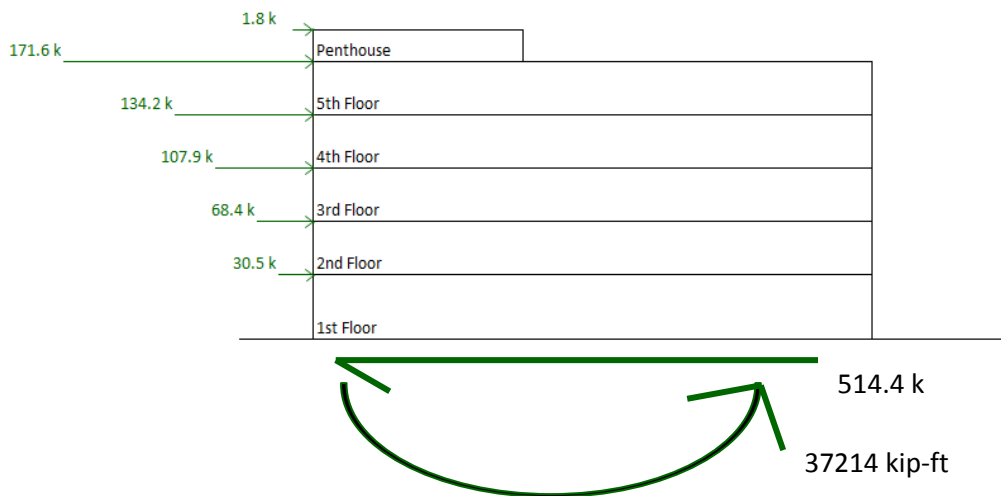

Figure 4.11: The seismic story forces, base shear and overturning moment.

The foundation system is comprised of piles that are driven to an elevation of 20 feet. Because they are driven, they have uplift capacity. Therefore, overturning moment for the Production Building is not a problem. Not only is the building extremely heavy due to high equipment loads and heavy framing, the foundation can resist almost as much uplift as it can gravity.

#### 4.4.5 Lateral Member Spot Checks

Lateral member spot checks were performed on the same two columns on which the gravity checks were calculated. For the gravity checks unbalanced moments due to pattern loading were taken into account. These moments were added to the lateral moments found in the lateral analysis. The first floor column was checked due to it having both the highest gravity and lateral loads. Both columns checked were found to be adequate. The controlling load case for both of the columns checked was  $1.2D + 1.6L + .5W$ . To see the full gravity calculations please see Appendix H. For full member checks see Appendix N. Figure 4.12 below shows the two columns spot checked.

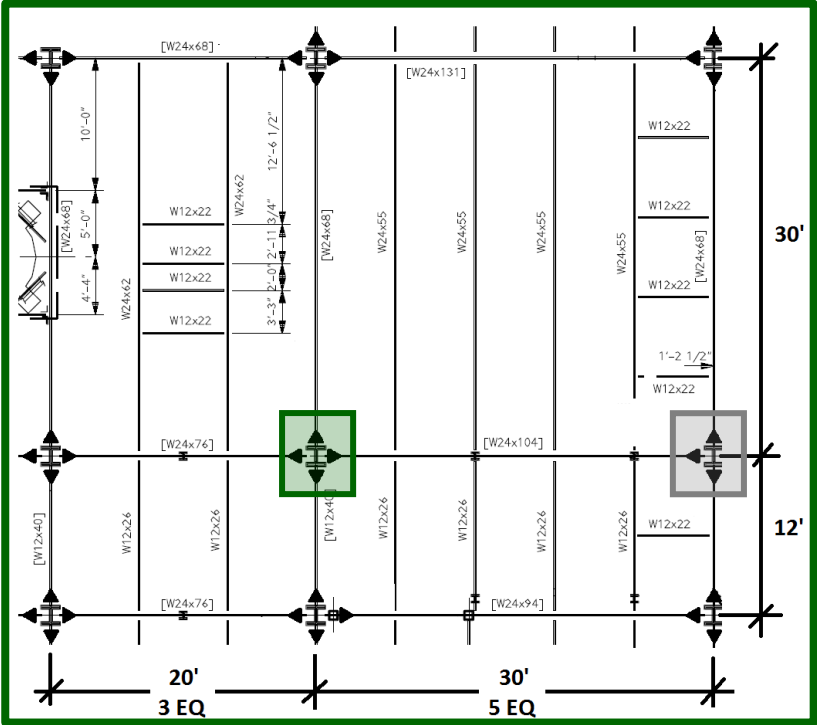

Figure 4.12: Floor plan courtesy of Project Engineer. The bay chosen to spot check. The interior column checked is highlighted in green. The exterior column checked is highlighted in grey.

## 4.4 Alternate Systems

To explore alternate gravity systems, an analysis of four floor systems was performed. Although the building was built using shear studs across each beam spaced at one foot on center, the designers did not design the system to work compositely. Therefore, for the purposes of this comparison, a non-composite beam and girder system will be the existing system used for comparison. This non-composite steel with concrete on metal deck system was compared to a composite concrete on metal deck system, a two-way flat slab system, and a one-way concrete joist system. Although the effects on the lateral system were not analyzed in this technical report, potential issues were noted. These effects will be further explored in future reports.

### 4.4.1 Non-composite Beam (Existing System)

The Production Building's current floor system is structural steel framing with 7.5 inches of normal weight concrete on 2VLI 18ga composite deck. For this alternate systems report, the non-composite beam system was redesigned slightly to be more comparable to other systems. The same bay used in spot checks was analyzed here as well. There are no additional point loads in this bay over the 200psf live load already included for the equipment. In addition, the longest span between beams does not fall within this bay. Although, 7 feet 11 inches is the longest span for the decking, the beams and girders at that spacing were increased in size. Therefore, a typical bay was analyzed and designed on the assumption that the areas with extra equipment point loads and irregular spacing would be designed separately.

A 2VLI 18ga composite deck with 6 inches of normal weight concrete was found adequate for the gravity loads. The 2VLI18 deck was chosen based on the longest spacing in the building, which is 7 feet 11 inches, and would not need to be shored at this distance.

The beams and girders designed by the engineers for the Production Building could have been downsized and still fit code requirements; however, the designers left extra capacity due to unknown future loading of the building. The beams designed by the engineers were W24x55, whereas in this redesign they could have been W21x50. The girders in the building were W24x109. The girders in the redesign are much smaller, though this is purely a gravity check. Each girder is also part of the lateral system, which would require them to have higher capacity. Based on gravity alone, the girders could have been as small as W24x62. Please see Appendix I for complete calculations of the existing system.

#### **Advantages**

Advantages to this system are its ease of construction. It is the most expensive of the systems compared; however, the beams and girders can be the lateral system as well. A large obstacle the designers had to overcome was the lack of space in the building. They did not have any room for bracing or shear walls in the system so they had to use only moment frames. This system allows there to be large spans between columns and a very open space on each floor to fit equipment and clean rooms. Also, this system works very well with high loadings as seen in the Production Building. This system is a lighter system than concrete floor systems which also decreased the need for more concrete piles in the foundation system.



### ***Disadvantages***

The main disadvantage to the non-composite beam system currently existing in the Production Building is not taking advantage of the concrete already above it to assist in flexural strength. This system is also the most expensive of the systems compared. Another disadvantage is thicker floor to floor heights. However, the floor to floor height is not a constraint in the Production Building. The floor to floor height is mostly driven by the vessels and piping that must fit above the ceiling, not by the W24s and concrete slab used. Larger floor to floor heights mean there is a higher wind load on the building. Lastly, the beams and girders in the non-composite beam system need to be fireproofed. This is usually done with spray fireproofing.

### **4.4.2 Composite Beam**

For the composite beam system, the same 2VLI 18ga composite deck with 6 inches of normal weight concrete was used. The loading on this system was taken to be the same (although ideally the beam allowance would be able to be decreased). The 2VLI18 deck was chosen based on the longest spacing in the building, which is 7 feet 11 inches, and would not need to be shored at this distance.

If the beams take advantage of composite action with the concrete already constructed on top of them the beams could be significantly smaller. The W21x50 beams calculated to work for non-composite action could have been downsized to W16x31 without needing to camber or shore anything. This saves a significant amount of steel weight. Using the rule of thumb that in a cost analysis each shear stud is equivalent to 10 pounds of structural steel, each beam saves about 300 pounds in steel cost. This adds to be a significant savings throughout every bay on each of the five floors. The girders are all part of the lateral system and, therefore, have negative moment at each column support. Because of this, no additional savings would incur by adding shear studs to the girders. The girders would not work compositely where the largest moments occur. Please see Appendix J for complete calculations for the composite beam system.

### ***Advantages***

This composite beam system has very little added construction costs to the existing non-composite beams. The Production Building was constructed as composite beams even though it was not designed to take advantage of the added strength. This system also has the same advantages as the non-composite beam system. It allows for longer spans and the lateral system can be comprised of the beams and girders. This system would not greatly impact the lateral system or the existing foundation system.

### ***Disadvantages***

This system also has the disadvantage of usually driving larger floor to floor heights. Although, there is no height restriction in the Production Building, a higher building does see more wind loads. Also, if there were a height restriction, the larger girders would make coordination with other disciplines harder. Lastly, this system must be fireproofed. The steel beams and girders would need to be fireproofed which also increases the cost of the building. This system is the second most expensive system to construct; however, in a tightly constricted building, it works well.

### 4.4.3 Flat Slab

The flat slab system is composed of a two way concrete slab with drop panels at each of the columns. Figure 4.7 shows the layout of a flat slab system. In order to effectively use a flat slab system, the bay sizes needed to be more equal. If not, the drop panels for the 12 foot bays would have run into each

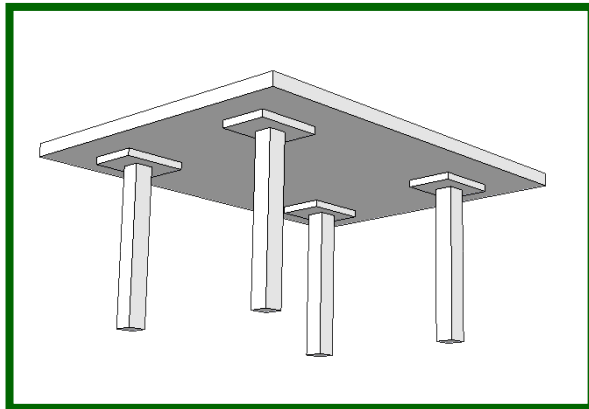

*Figure 4.9:* A sketchup model of the layout of a two-way flat slab system.

other. Therefore, the three bays were averaged into three 24 foot bays. The bays then analyzed were 30 feet by 24 feet. The thickness of the slab is 12 inches and the drop panels are 4.25 inches. These drop panels are conservative, but the 4.25 inch depth was chosen for ease of construction. 4.25 inches is the length of a 2x4 with the plyform thickness on top. The drop panel dimensions are 10 feet by 8 feet. The punching shear did not control as in most two-way systems. Flexure controlled the addition of drop panels and the thickness of the slab. Please see Appendix K for complete calculations for the flat slab system.

#### **Advantages**

This system works well with medium spans and large loads. One advantage to flat slab construction is the low floor to floor height. When height restrictions are involved the thin slab with the drop panels allows the other disciplines to coordinate more easily without making the entire system the thickness required for punching shear. Often this can also decrease the cost of the finishing system of the ceiling. This allows finishing products to be applied directly to the slab if the owner or architect desires. The Production Building, however, has no height restrictions. It may be cheaper to make a thicker slab with less reinforcing than thinner slab with more reinforcing due to the high labor costs of tying rebar. This system is the cheapest to construct in Virginia.

#### **Disadvantages**

The flat slab system can have high labor costs due to the extra formwork used to frame out the drop panels. These costs can be kept down by using the same module for the entire building and by building the system slightly more conservative but with common formwork dimensions; this allows for formwork to be reused throughout construction. Lastly, a concrete system is heavier than a steel system which would increase earthquake loads and impact the foundation system. Because the Production Building sits on concrete piles, a lighter system would be preferable. Also, for this solution, the bay sizes in the Production Building were averaged. This would have a large impact on the lateral system. There was very little room to fit a shear wall into this building, however the building could be designed as concrete moment frame. Although, the system has many advantages it is not a viable solution to the Production Building's constraints.

#### 4.4.4 One-Way Slab

The one-way slab system works very well with long spans and large loads. For this system the slab is thin and sits on beams which then sit on girders. Please see figure 4.10 for the layout of the one-way slab in the 24 by 30 foot bay. The same bay spacing was analyzed for the one-way system as was in the two-way system in section 4.4.3. Most of the bays in the Production Building would be 20 feet by 24 feet with only the last bay spanning 30 feet by 24 feet. For this reason, in the 30 foot by 24 foot bay analyzed the beams run the short direction and are spaced 10 feet on center. Using the CRSI manual, the slab is 6 inches deep, while the beams are 20 inches deep, 14 inches wide, and the girders are 28 inches deep and 20 inches wide. Please see Appendix L for complete calculations for the one-way concrete slab system.

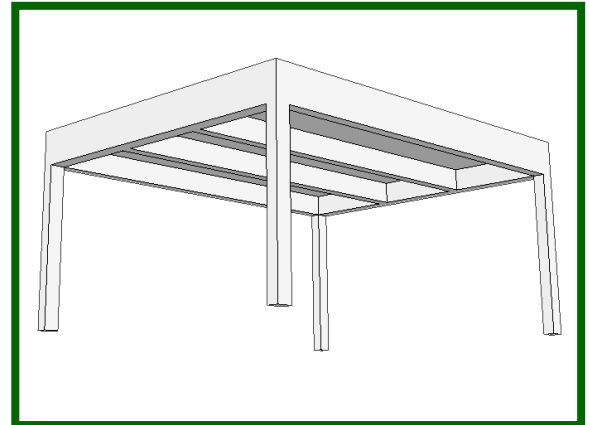

Figure 4.10: A sketchup model of the layout of the one-way slab system.

#### Advantages

This system uses less concrete than other concrete systems and therefore has less building weight. A lighter building is not always an advantage but often can be. This system is easy for coordination of systems because electrical fixtures can be placed between the beams. One large benefit to the one-way slab system is the vibration control. This system works the best for vibration out of the four systems analyzed.

#### Disadvantages

This system can be extremely expensive to construct. Because of the large amount of formwork to be placed, the labor costs can get very expensive. This system is the second cheapest system for the Production Building. This system works well for longer spans but not as well for shorter spans. In addition, the one-way slab has a larger structural depth than flat the flat slab system. This system also weighs much more than the existing system, which would impact earthquake loading as well as the foundation system. The foundation system the Production Building is built upon is concrete piles. These are extremely expensive foundation systems to expand, so a lighter structure would be better.

#### 4.4.5 Comparisons Between Systems

The Production Building has much higher loads than seen in the average building, so many of the systems that would work well for the bay spacing in an average building are not as economical. The systems were compared based on impacts on the building's lateral and gravity systems, foundation impact, weight, system depth, cost, constructability, and vibration to determine if viable for further study. The systems found feasible will need to be checked for lateral loads.

	Existing	Alternate Systems		
	Non-composite Beam	Composite Beam	Two-Way Flat Slab	One-Way Slab
Bay Change	<b>None (30'x30')</b>	<b>None (30'x30')</b>	24'x30'	24'x30'
Lateral System Impact	<b>No</b>	<b>No</b>	Yes	Yes
Weight	73.8 PSF	<b>71.3 PSF</b>	156 PSF	129 PSF
Foundation Impact	<b>No</b>	<b>No</b>	Yes	Yes
System Depth	31.5 in.	31.5 in.	<b>16.25 in.</b>	28 in.
Cost	\$37.96/SF	\$23.83/SF	<b>\$16.01/SF</b>	\$18.41/SF
Constructability	<b>Good</b>	<b>Good</b>	Average	Below Average
Vibration	Average	Average	Average	<b>Good</b>
Viable Solution	N/A	<b>Yes</b>	Yes	Yes

Table 4.1: A summary comparison between floor systems.

Table 4.1 above shows a summary of the four systems. The best systems moving forward for further study are the existing non-composite and the composite beam systems.

## 5.0 Conclusions

By analyzing each part of the structural system, it was clear how each individual system works together in the structural integrity of the Production Building. By verifying each load, a greater understanding was gained for the considerations that designers must address. By building a structural model in ETABS a greater understanding of the load path and distribution throughout the lateral system was attained. The torsional irregularity of the Production Building provided valuable insight into the behavior of the structure under lateral loads. Using spot checks, the structure was determined to have adequate strength.

The lack of space in the building footprint drove the majority of design decisions for the Production Building. Engineers had to design the entire lateral system from moment connections at every girder and beam framing into the columns. The possibility of attempting to redesign the structure in concrete could be explored.

The spot checks performed also revealed the beams and girders were not designed to take advantage of the large amount of concrete on top of the composite deck. A study to determine if money could have been saved based on the assumptions used for this report.

After designing three new systems to compare to the existing floor and gravity system in the Production building, it was established that the best solution to continue analyzing would be the composite steel beam. The two-way flat plate and one-way slab impact the lateral and foundation systems enough to make them not viable solutions to the constraints of this building.

# 6.0 Appendices

## Appendix A: Framing Plans

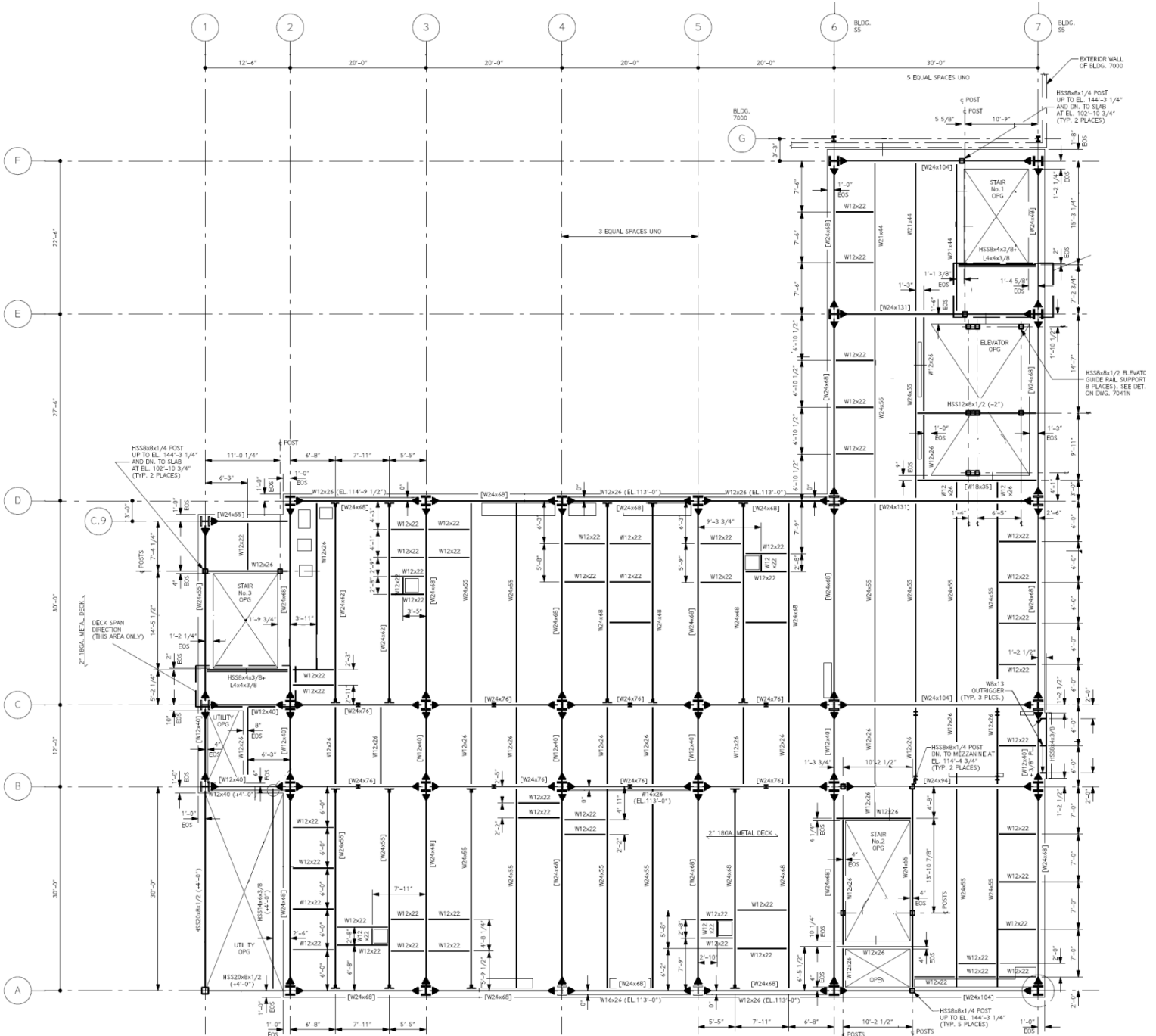

Figure A.1: Courtesy of Project Engineer. The second floor framing plan.

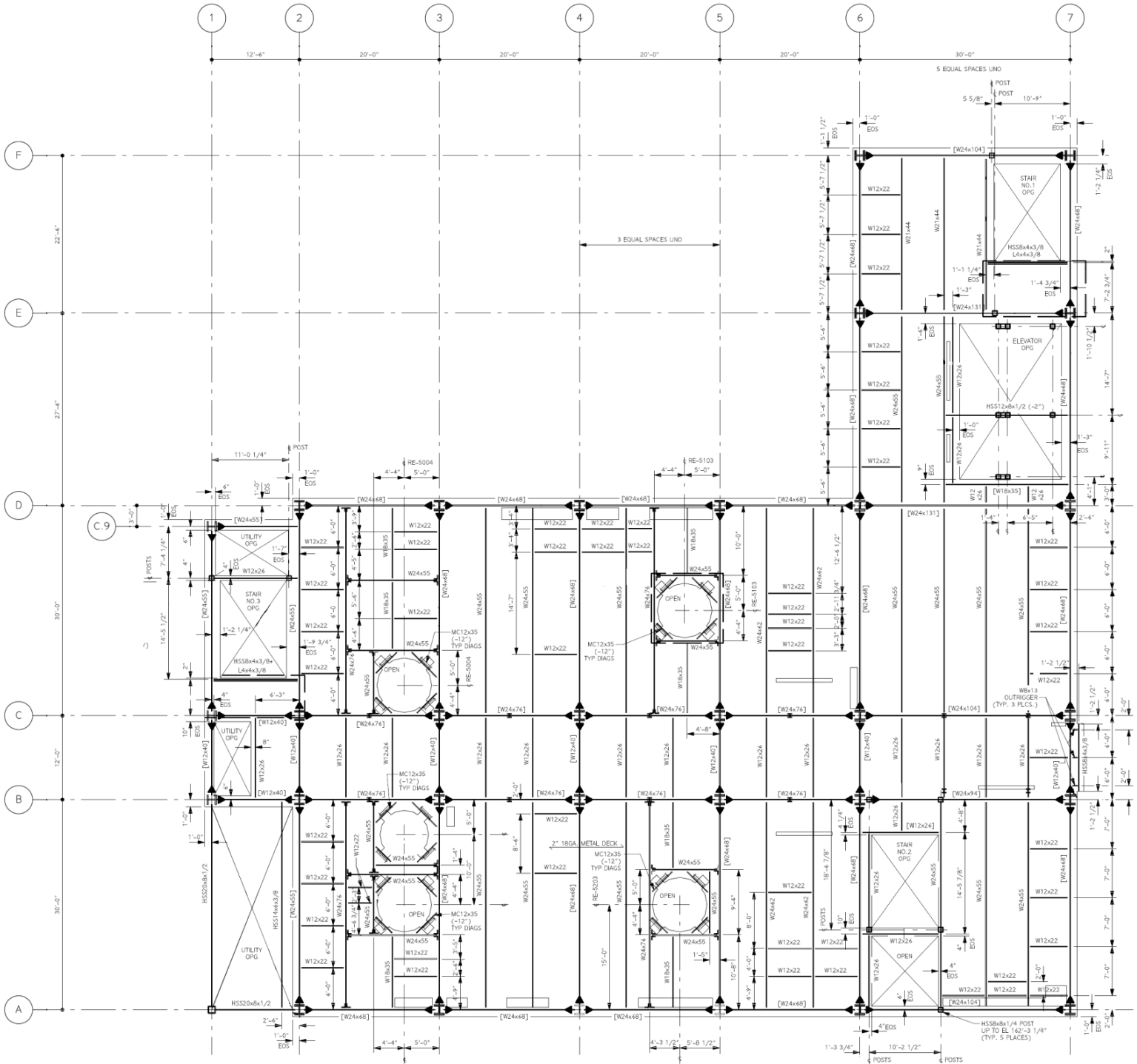

Figure A.2: Courtesy of Project Engineer. The third floor framing plan.

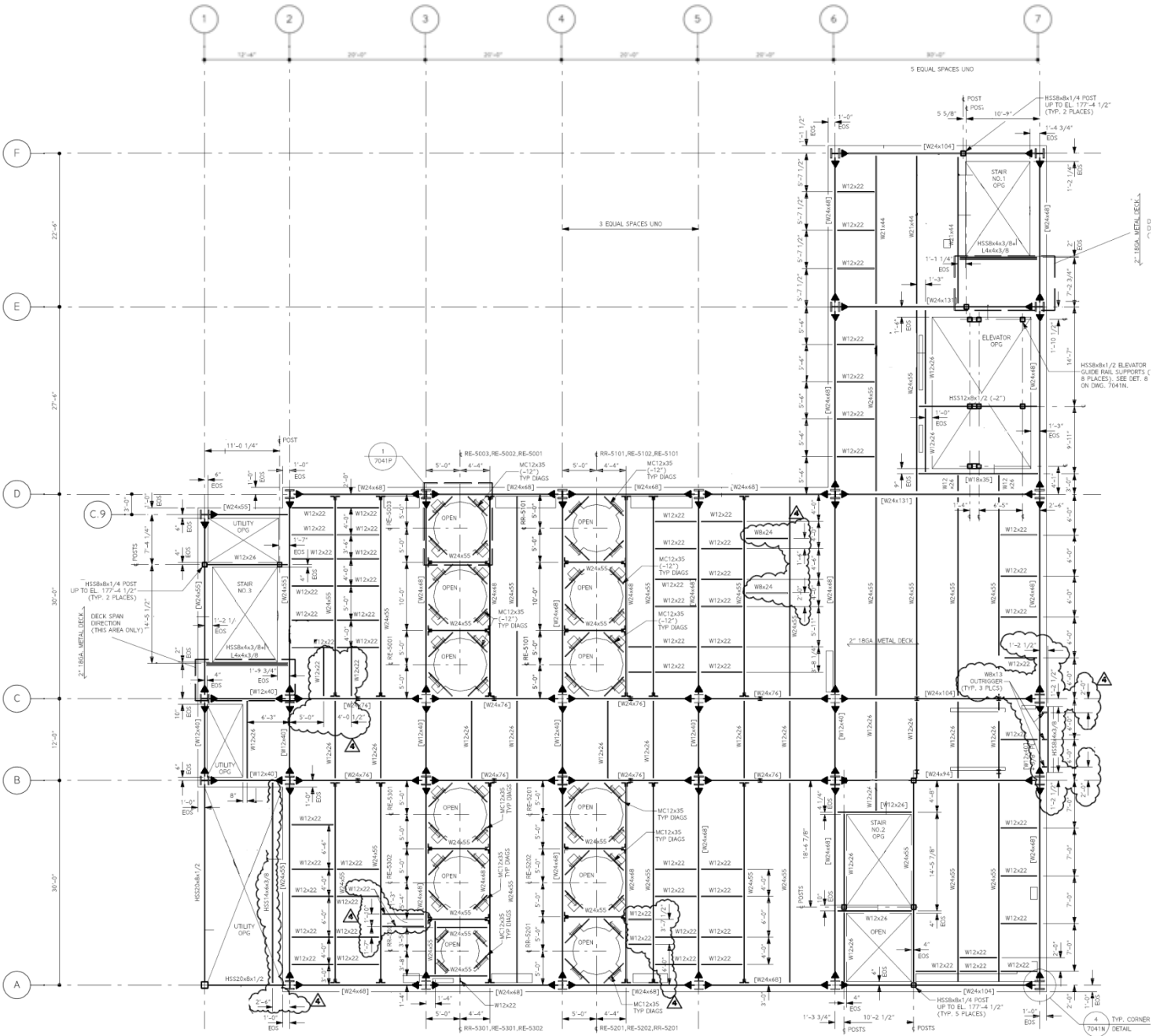

Figure A.3: Courtesy of Project Engineer. The fourth floor framing plan.



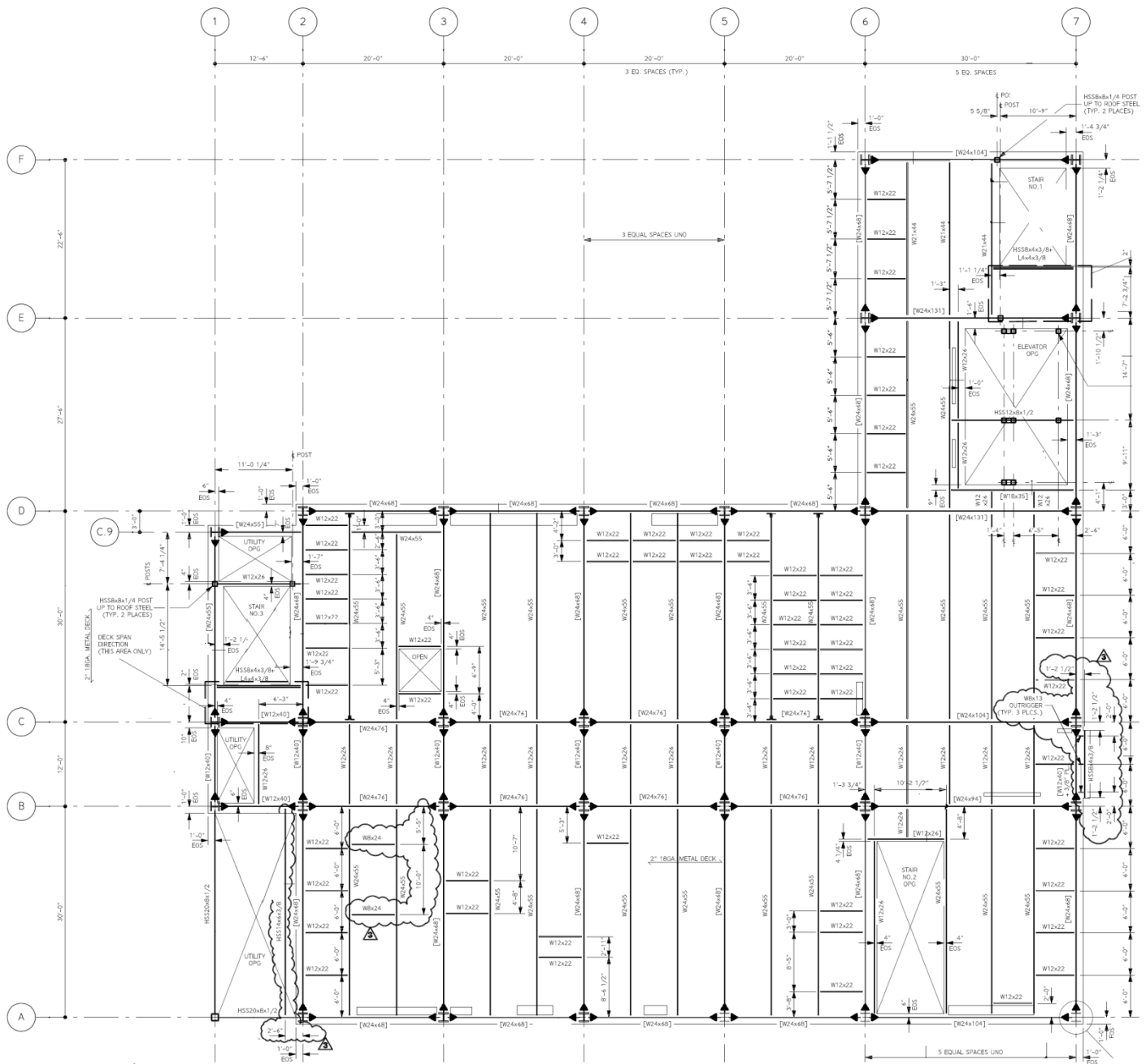

Figure A.4: Courtesy of Project Engineer. The fifth floor framing plan.

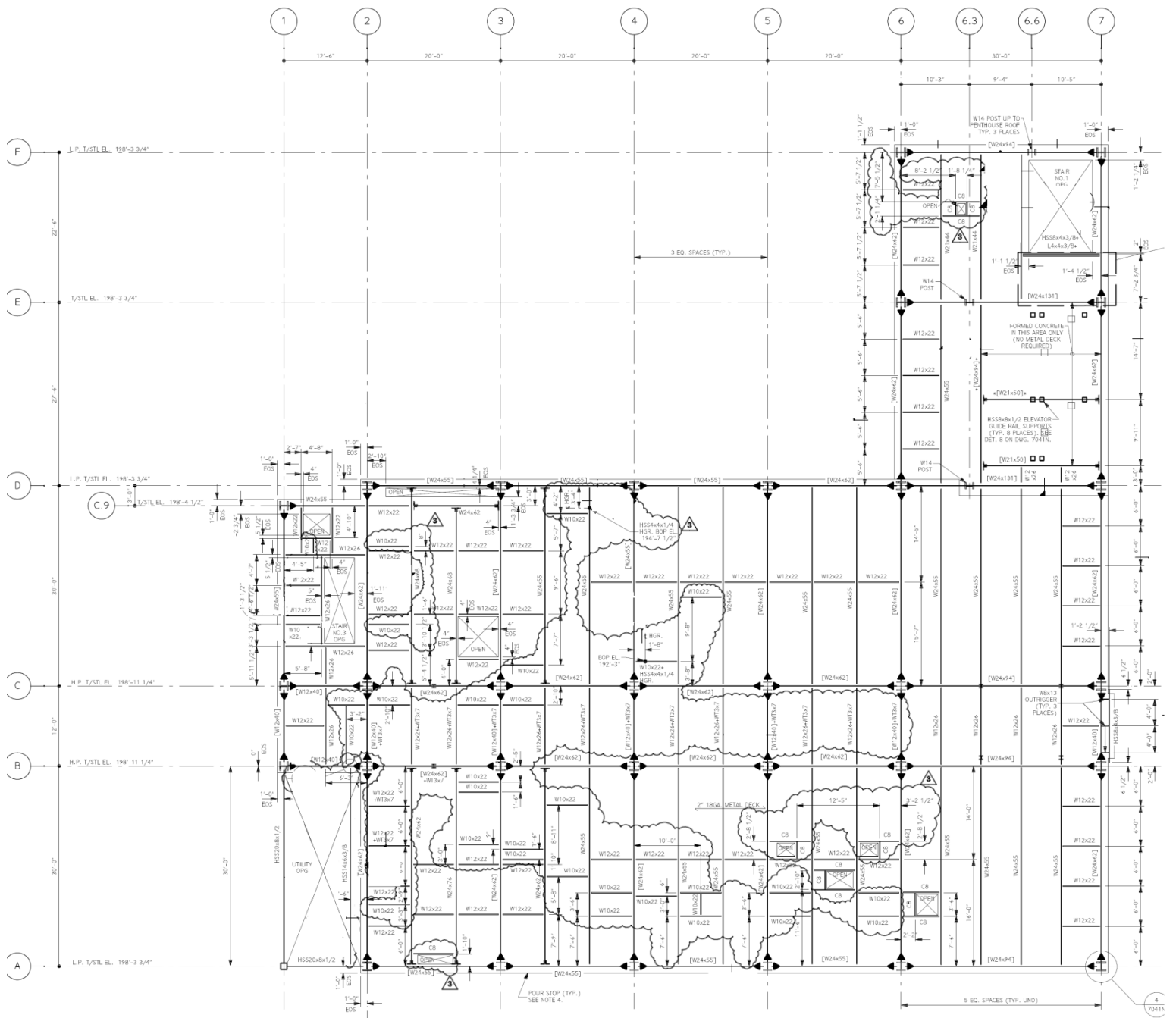

Figure A.5: Courtesy of Project Engineer. The roof framing plan.

## Appendix B: Equipment Loads per Floor

The following table is a copy of the table shown in the dead loads section of the main report. These equipment loads are only the loads that exceed the live load for the floor. The following images show the general location of equipment, but are for design purposes only. The equipment numbers assigned in the table correspond to the numbers on the plans.

Equipment Loads per Floor											
First Floor		Second Floor		Third Floor		Fourth Floor		Fifth Floor		Roof Level	
No.	Operational Weight	No.	Operational Weight	No.	Operational Weight	No.	Operational Weight	No.	Operational Weight	No.	Operational Weight
1	47 k	1	31 k	1	44 k	1	44 k	1	11 k	1	20 k
2	56 k	2	31 k	2	40 k	2	25 k	2	3 k	2	102 k
3	50 k	3	27 k	3	36 k	3	23 k	3	6 k	3	126 k
4	25 k	4	27 k	4	51 k	4	23 k	4	2 k	4	26 k
5	58 k			5	21 k	5	51 k	5	2 k	5	11 k
6	36 k			6	23 k	6	44 k				
				7	11 k	7	21 k				
						8	29 k				

Table B.1: Equipment dead loads per floors. These point loads are only the loads that exceed the live load for the floor.

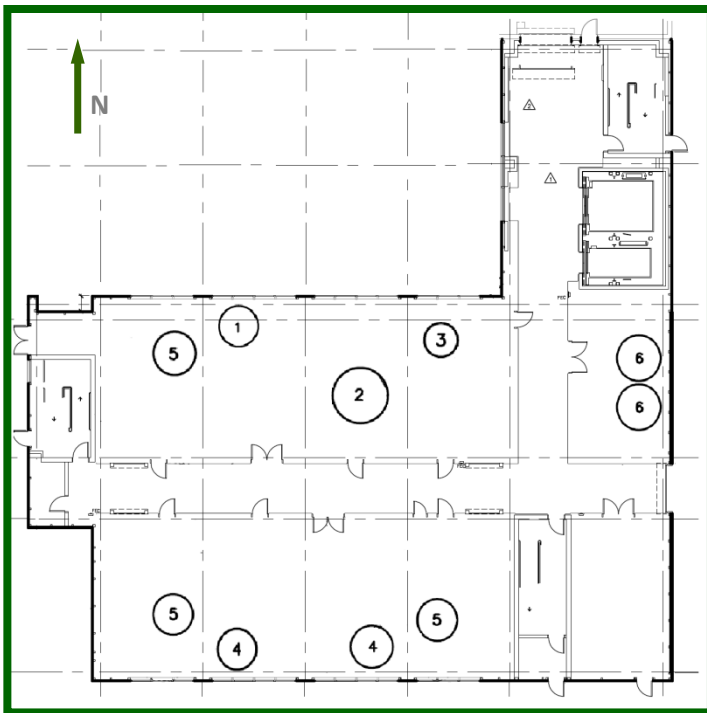

Figure B.1: Equipment dead loads on the First Floor.

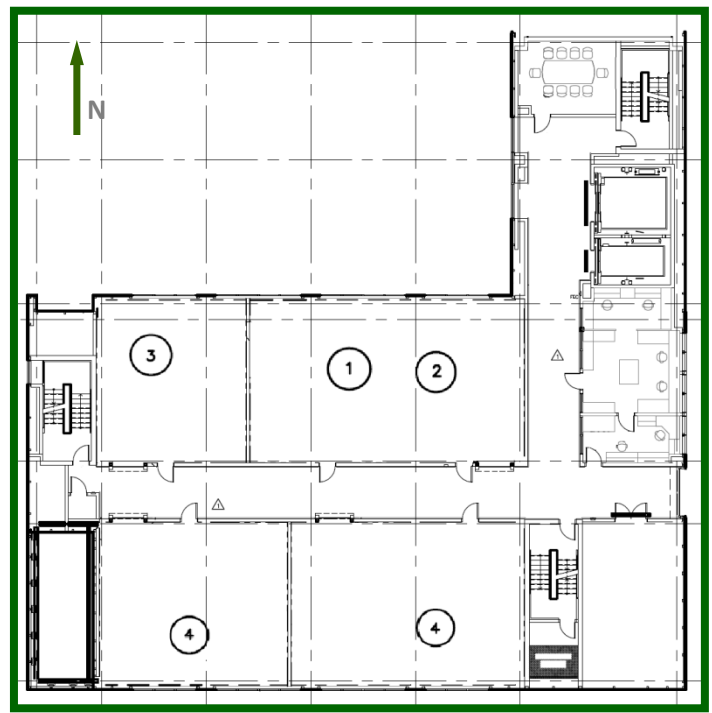

Figure B.2: Equipment dead loads on the Second Floor.

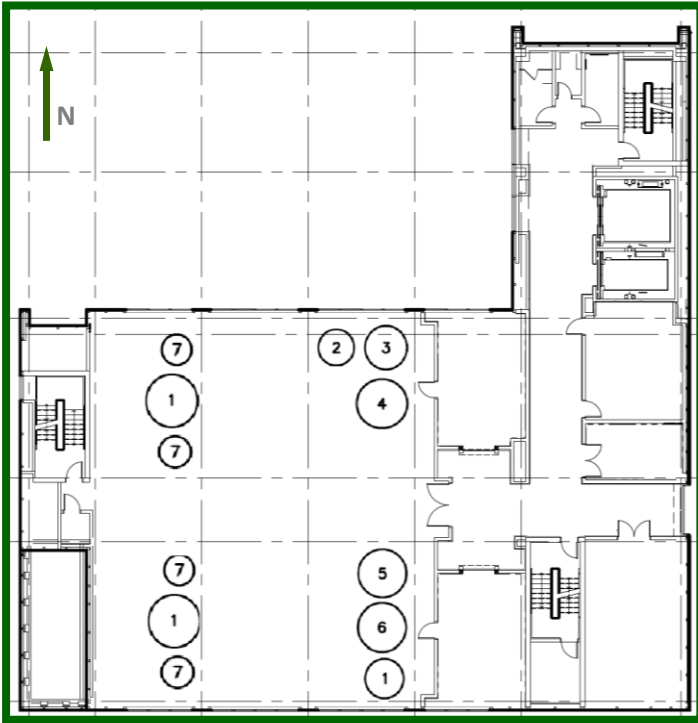

Figure B.3: Equipment dead loads on the Third Floor.

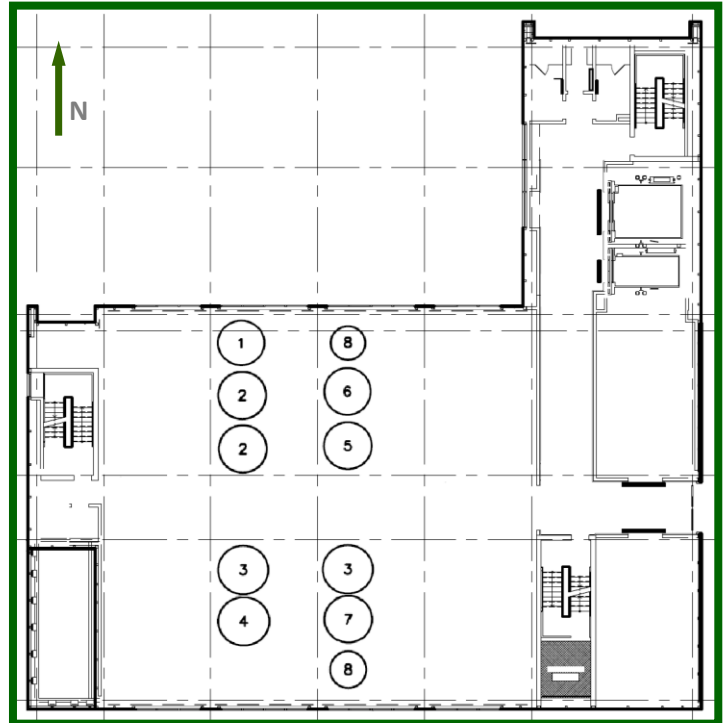

Figure B.4: Equipment dead loads on the Fourth Floor.

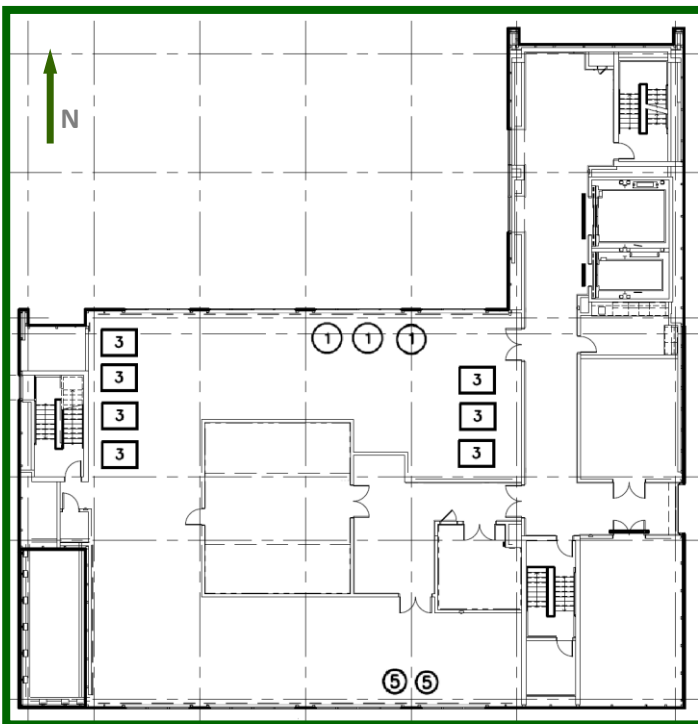

Figure B.5: Equipment dead loads on the Fifth Floor.

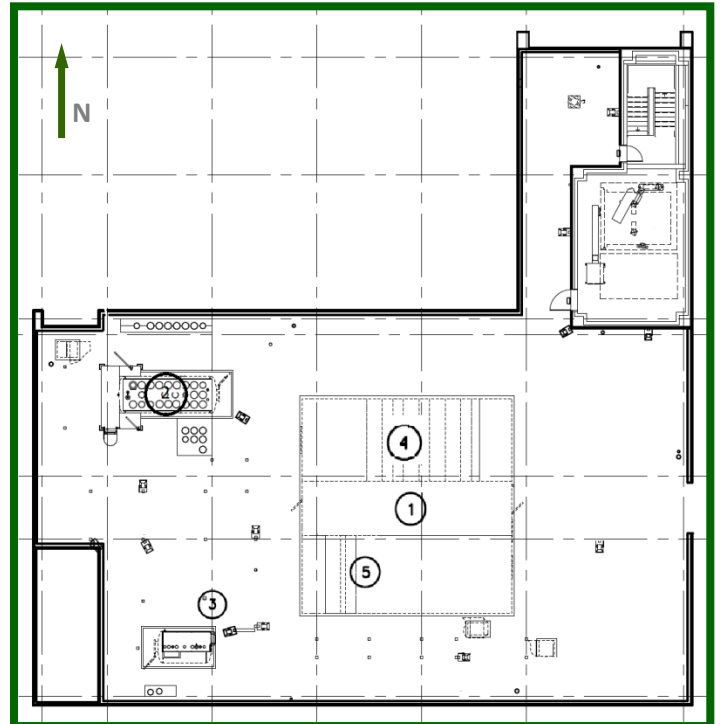
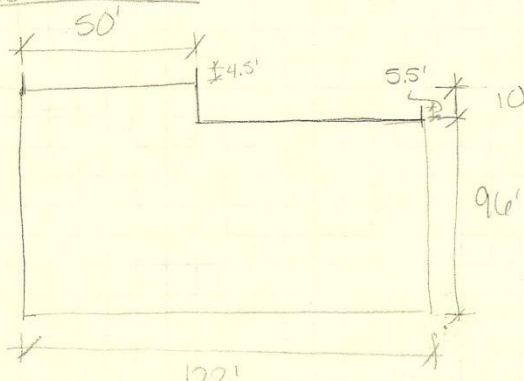

Figure B.6: Equipment dead loads on the Roof.

## Appendix C: Snow Load Calculations

SNOW	Christina DiPaolo	1
<p>3-0235 — 50 SHEETS — 5 SQUARES            3-0236 — 100 SHEETS — 5 SQUARES            3-0237 — 200 SHEETS — 5 SQUARES            3-0137 — 200 SHEETS — FILLER</p> <p>COMET</p>	<p>Ground snow Load = 25 psf</p> <p>Flat Roof</p> $P_f = .7 C_e C_t I_s P_g = .7(1.0)(1.0)(1.1)(25) = 19.3 \text{ psf}$ <p><math>C_e = 1.0</math> (partially exposed + exposure c)</p> <p><math>I_s = 1.10</math></p> <p><math>C_t = 1.0</math></p> <p><u>Drift to Penthouse</u></p>  <p><math>h_d = \frac{P_s}{\gamma} = \frac{19.3}{17.25} = 1.1 &gt; 2</math>  <math>\therefore</math> calculate drift</p> <p><math>\gamma = .13(25) + 14 = 17.25</math> (eq 7.7-1)</p> <p><math>l_u = 50 \text{ ft}</math>      <math>W = 4h_d = 4(2.3) = 9.2</math></p> <p><math>h_d = 2.3</math> (from Fig 7-9)</p> <p><math>P_d = h_d \gamma = 2.3(17.25) = \boxed{39.7 \text{ psf}}</math></p> <p>4.5' tall parapet <sup>on penthouse</sup> (<math>1.1 + 2.3 = 3.4 &lt; 4'</math>) Don't need to check leeward wind.</p> <p><u>Drift on Penthouse due to Parapets</u></p> <p><math>l_u = 50 \text{ ft}</math></p> <p><math>h_d = 2.3(.75) = 1.73</math></p> <p><math>P_d = h_d \gamma = 29.8 \text{ psf}</math></p>	

SNOW

Christina DiPaolo

2

Drift on Roof due to Parapets

$$l_u = 122 \text{ ft}$$

$$\begin{aligned} .75 h_d &= [.43 \sqrt[3]{l_u} \sqrt[4]{p_g + 10} - 1.5] .75 \\ &= [.43 \sqrt[3]{122} \sqrt[4]{35 - 1.5}] .75 \\ &= 3.7 (.75) = 2.8 \end{aligned}$$

$$P_d = 2.8 (17.25) = \boxed{48.3 \text{ psf}}$$

3-0285 — 50 SHEETS — 5 SQUARES  
3-0286 — 100 SHEETS — 5 SQUARES  
3-0287 — 200 SHEETS — 5 SQUARES  
3-0137 — 200 SHEETS — FILLER

COMET

## Appendix D: Wind Load Calculations

East-West Wind										
Floor	Elev	$h_i$	$z$	$k_z$	$q_z$	Windward Pressure, $p$ (psf)	Windward Force (k)	Leeward Pressure, $p$ (psf)	Leeward Force (k)	
1	102.9	0	0	0.85	24.5	20.2	29.5	-19.4	-28.4	
2	126.9	24	24	0.94	27.1	22.3	54.0	-19.4	-49.7	
3	144.9	18	42	1.05	30.2	24.9	51.8	-19.4	-42.6	
4	162.9	18	60	1.13	32.5	26.8	56.8	-19.4	-42.6	
5	180.9	18	78	1.20	34.5	28.5	60.7	-19.4	-42.6	
Roof	198.9	18	96	1.25	36.0	29.6	58.4	-19.4	-39.1	
PH	208.9	15	111	1.31	37.7	31.1	11.1	-19.4	-7.3	
$\Sigma =$							292.7	$\Sigma =$		-224.0
							Base Shear = 516.7 k			
							Overturning Moment = 29832.2 k-ft			

Table D.1: The East-West wind Excel calculations for the windward and leeward pressures and forces per floor level.

North - South Wind										
Floor	Elev	$h_i$	$z$	$k_z$	$q_z$	Windward Pressure, $p$ (psf)	Windward Force (k)	Leeward Pressure, $p$ (psf)	Leeward Force (k)	
1	102.9	0	0	0.85	24.5	20.2	29.6	-19.4	-28.5	
2	126.9	24	24	0.94	27.1	22.3	54.2	-19.4	-49.9	
3	144.9	18	42	1.05	30.2	24.9	52.0	-19.4	-42.8	
4	162.9	18	60	1.13	32.5	26.8	57.0	-19.4	-42.8	
5	180.9	18	78	1.20	34.5	28.5	60.9	-19.4	-42.8	
Roof	198.9	18	96	1.25	36.0	29.6	58.6	-19.4	-39.2	
PH	208.9	15	111	1.31	37.7	31.1	3.3	-19.4	-2.2	
$\Sigma =$							286.1	$\Sigma =$		-219.8
							Base Shear = 505.9 k			
							Overturning Moment = 29954.5 k-ft			

Table D.2: The North-South wind Excel calculations for the windward and leeward pressures and forces per floor level.

WIND LOADS

V = 115 mph (Figure 26.5-1A)

EXPOSURE C (from drawings)

Importance Factor(?) = 1.15 (from drawings)

 $K_d = .85$  (Table 26.6-1) $K_{zt} = 1.0$  (26.8.2) $G_{Cpi} = \pm .18$ 

- enclosed building

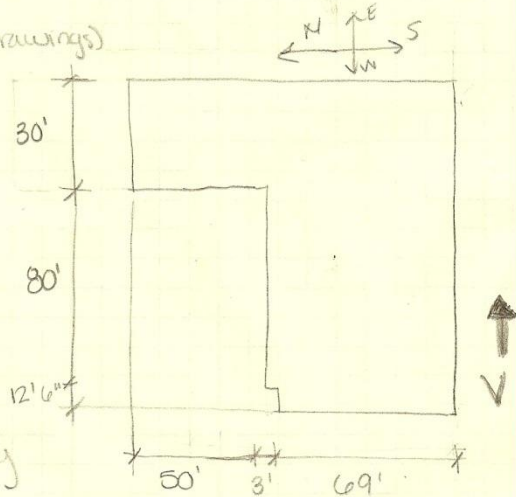

Approximate Natural Frequency

$$L_{eff} = \frac{\sum_{i=1}^n h_i L_i}{\sum_{i=1}^n h_i} = \frac{11937}{111} = 107.5$$

$$n = 111 \ll 4(107) = 430 \quad \checkmark \text{ yes} \\ \text{approx freq applies}$$

Structural steel moment frame

$$n_a = 22.2/n^3 = 22.2/(111)^3 = .53 < 1 \quad \therefore \text{Flexible}$$

East-West

Gust Factor

$$G_E = .925 \left( \frac{1 + 1.7 I_z \sqrt{g_Q^2 Q^2 + g_R^2 R^2}}{1 + 1.7 g_v I_z} \right)$$

$$g_Q = 3.4$$

$$g_v = 3.4$$

$$I_z = C \left( \frac{33}{z} \right)^{1/6} = .20 \left( \frac{33}{68.6} \right)^{1/6} = .161$$

$$\bar{z} = .6h = .6(111) = 66.6 > 15 \quad \checkmark \text{ OK}$$

$$C = .20 \quad (\text{Table 26.9-1})$$

$$g_R = \sqrt{2 \ln(3600(.53))} + \frac{.577}{\sqrt{2 \ln(3600(.53))}} = 4.035$$

3-0235 — 50 SHEETS — 5 SQUARES  
 3-0236 — 100 SHEETS — 5 SQUARES  
 3-0237 — 200 SHEETS — 5 SQUARES  
 3-0137 — 200 SHEETS — FILLER

COMET



$$Q = \sqrt{\frac{1}{1 + .63 \frac{(B+h)}{L_z}}} = \sqrt{\frac{1}{1 + .63 \left( \frac{122 + 111}{570.1} \right)}} = .893$$

$$B = 122$$

$$h = 96$$

$$L_z = l \left( \frac{\bar{z}}{33} \right)^{\bar{z}} = 500 \left( \frac{63.6}{33} \right)^2 = 570.1$$

$$l = 500 \text{ (Table 26.9-1)}$$

$$\bar{z} = 150 \text{ (Table 26.9-1)}$$

$$R = \sqrt{\frac{1}{B} R_n R_h R_B (.53 + .47 R_L)} = \sqrt{\frac{1}{.01} (.0775) (.357) (.321) (.53 + .47 (.112))} = .719$$

$$R_n = \frac{7.47 N_1}{(1 + 10.3 N_1)^{5/3}} = \frac{7.47 (2.53)}{(1 + 10.3 (2.53))^{5/3}} = .0775$$

$$N_1 = \frac{n_1 L_z}{\sqrt{\bar{z}}} = \frac{(.58)(570.1)}{119.4} = 2.53$$

$$\sqrt{\bar{z}} = \bar{b} \left( \frac{\bar{z}}{33} \right)^{\bar{\alpha}} \left( \frac{88}{60} \right) \sqrt{V} = .65 \left( \frac{57.6}{33} \right)^{1/6.5} \left( \frac{88}{60} \right) 115 = 119.4$$

$$\bar{b} = .65 \text{ (table 26.9-1)}$$

$$\bar{\alpha} = 1/6.5 = .154 \text{ (table 26.9-1)}$$

$$R_h = \frac{1}{n} - \frac{1}{2n^2} (1 - e^{-2n}) = \frac{1}{2.16} - \frac{1}{2(2.16)^2} (1 - e^{-2(2.16)}) = .357$$

$$n = 4.6 n_1 h / \sqrt{\bar{z}} = 4.6 (.53) (111) / (119.4) = 2.16$$

$$R_B = \frac{1}{n} - \frac{1}{2n^2} (1 - e^{-2n}) = \frac{1}{2.49} - \frac{1}{2(2.49)^2} (1 - e^{-2(2.49)}) = .321$$

$$n = 4.6 n_1 B / \sqrt{\bar{z}} = 4.6 (.53) (122) / 119.4 = 2.49$$

$$R_L = \frac{1}{n} - \frac{1}{2n^2} (1 - e^{-2n}) = \frac{1}{8.37} - \frac{1}{2(8.37)^2} (1 - e^{-2(8.37)}) = .112$$

$$n = 15.4 n_1 L / \sqrt{\bar{z}} = 15.4 (.53) (122.5) / 119.4 = 8.37$$

$B = \text{damping ratio} = .01$  for steel building

WIND

Christina DiPaolo

3

$$G_F = .925 \left( \frac{1 + 1.7(.161) \sqrt{(3.4)^2 (.893)^2 + (4.03)^2 (.719)^2}}{1 + 1.7(3.4)(.161)} \right) = 1.03$$

 $K_n$ 

$$h = 100, \text{ exposure C} \Rightarrow K_n = 1.31$$

Velocity Pressure

$$q_z = .00256 K_n K_{zt} K_d V^2 = .00256 (1.31) (1.0) (.85) (115)^2 = 37.7 \text{ psf}$$

 $C_p$  (Figure 27.4-1)

Windward  $C_p = .8$

Leeward  $4/8 = 122.5/122 = 1.0$   $C_p = -.5$

Side Wall  $C_p = .7$

Roof (flat)

$$h/L = .78, \theta < 10^\circ$$

$$\begin{array}{l} 1.0 \\ .5 \end{array} \begin{array}{l} -13 \\ -.9 \end{array} \left\{ \begin{array}{l} 1.0 - .78 \\ 1.0 - .5 \end{array} \right\} = \frac{-13 - C_p}{-13 - .9}$$

$$C_p = -1.124$$

Wind pressure

$$P = q G_F C_p - q_i (G_{pi})$$

Windward

not needed  
fully enclosed

$$P = q_z (1.03) (.8) = .824 q_z \text{ psf}$$

\* see table

Leeward

$$P = (37.7) (1.03) (.5) = -18.9 \text{ psf}$$

\* repeated for North South wind

3-0235 — 50 SHEETS — 5 SQUARES  
3-0236 — 100 SHEETS — 5 SQUARES  
3-0237 — 200 SHEETS — 5 SQUARES  
3-0137 — 200 SHEETS — FILLER

COMET

## Appendix E: Seismic Load Calculations

Floor	Dead Load (psf)	Area (SF)	Exterior Wall (k)	Equipment PL (k)	Total Weight (k)
1	200	10320	59	449	2572
2	180	10320	103	143	2103
3	180	10320	88	347	2293
4	180	10320	88	337	2283
5	180	10320	88	79	2025
ROOF	160	10320	45	285	1981
Penthouse	20	750	3.6	0	19
$\Sigma =$					13274

Table E.1: The excel calculations for floor weight.

Floor	Total Weight (k)	z (ft)	$w_x h_x^k$	$C_{vx}$	$F_x$ (k)
1	2572	0	0	0	0
2	2103	24	126874	0.06	30.5
3	2293	42	284658	0.13	68.4
4	2283	60	449002	0.21	107.9
5	2025	78	558657	0.26	134.2
ROOF	1981	96	714527	0.33	171.6
Penthouse	18.6	106	7624	0.00	1.8
$\Sigma =$			2141342	1.0	514.4
Overturning Moment =					37214

Table E.2: The excel calculations for story shear and overturning moment.

SEISMIC

ZIP = 23805

Christina DiPaolo

1

$$S_s = .155 \text{ (USGS)}$$

$$F_a = 2.5 \text{ (Table 11.4-1)}$$

$$S_1 = .059 \text{ (USGS)}$$

$$F_v = 3.5 \text{ (Table 11.4-2)}$$

Soil site class E

$$S_{MS} = F_a S_s = (2.5)(.155) = .3875$$

$$S_{M1} = F_v S_1 = (3.5)(.059) = .2065$$

$$S_{D5} = (2/3) S_{MS} = 2/3 (.3875) = .258 \Rightarrow B$$

$$S_{D1} = (2/3) S_{M1} = 2/3 (.2065) = .138 \Rightarrow C$$

Design category = C (worse of two)

$$I = 1.25$$

$$R = 3.5 \text{ (steel mem. frame)}$$

3-0285 — 50 SHEETS — 5 SQUARES  
 3-0236 — 100 SHEETS — 5 SQUARES  
 3-0237 — 200 SHEETS — 5 SQUARES  
 3-0137 — 200 SHEETS — FILLER

COMET

Equivalent Lateral Force Analysis

$$C_s = \frac{S_{D5}}{\left(\frac{R}{I}\right)} = \frac{.26}{\left(\frac{3.5}{1.25}\right)} = .09$$

$$T_a = C_t h_n^x = .028(96)^{.8}$$

$$= 1.08$$

$$C_t = .028 \text{ (steel mem. frame)}$$

$$C_s = \frac{S_{D1}}{T(R/I)} = \frac{.138}{1.08(3.0/1.25)} = .053 \leftarrow \text{CONTROLS}$$

$$x = .8$$

$$\text{Table 12.8-2}$$

$$C_s = .044(26)(1.25) \geq .01$$

$$= .0143 \geq .01 < .05 \quad \checkmark \text{ OK}$$

$$T_L = 8 \text{ (Fig 22-12)}$$

$$T_a < T_L$$

$$V = C_s W$$

\* Weight by floor + total calculated in excel

$$W = 102876 \text{ k}$$

$$V = .05(102876) = 5144 \text{ k}$$

Vertical Distribution of seismic forces

$$F_x = C_v x V$$

$$C_v x = \frac{W_x h_x^k}{\sum_{i=1}^n W_i h_i^k}$$

$$k = 1.29 \text{ (Section 12.8.3)}$$

\* see excel for calculation of  $F_x$

## Appendix F: Floor Spot Check Calculations

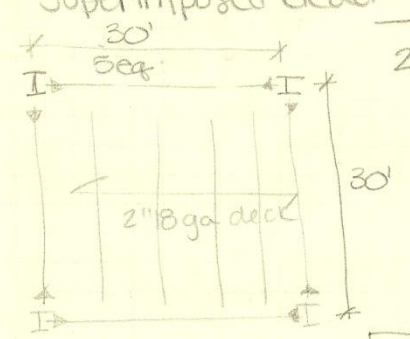
	Floor Check	Christina DiPaolo	1
<p>3-0285 — 50 SHEETS — 5 SQUARES            3-0286 — 100 SHEETS — 5 SQUARES            3-0287 — 200 SHEETS — 5 SQUARES            3-0137 — 200 SHEETS — FILLER</p> <p>COMET</p>	<p><u>3rd floor</u></p> <p>Live Load = 200psf            Superimposed dead = 98psf</p> <p><math>298\text{psf}</math> (load greater than 200 contact Vulcraft)</p>  <p><math>30/5 = 6' \Rightarrow</math> use <span style="border: 1px solid black; padding: 2px;">2VL118 w/ 4" NWC</span></p> <p><math>324\text{psf} &gt; 298\text{psf}</math></p> <p>Check unshared length:  <math>3\text{span} = 12'-9" \gg 6'</math></p> <p>also I am ignoring point loads located in other parts of the building and the largest span is 7'-11".</p> <p><u>used</u> <math>\rightarrow 7\frac{1}{2}"</math> NWC on 2VL118 <math>\rightarrow</math> NOT even in the deck manual</p> <p><math>6"</math> NWC on 2VL118 hold 400psf <math>\gg 298\text{psf}</math></p>		

## Appendix G: Beam and Girder Spot Check Calculations

### Beam Calculations

	Beam Check	Christina DiPaolo
<p>3-0235 — 50 SHEETS — 5 SQUARES            3-0236 — 100 SHEETS — 5 SQUARES            3-0237 — 200 SHEETS — 5 SQUARES            3-0137 — 200 SHEETS — FILLER</p>	 <p>30' 5 eq spaces</p> <p>30'</p> <p>Composite beam: W24x55 [28]  <math>t = .505</math>  <math>A = 16.2</math>  <math>b_f = 7.01</math></p> <p>5 1/2" 2"</p> <p>COMET</p> <p>36" y2</p> <p>30' y1</p> <p><math>Q_n = 21.5 \text{ k}</math> (Table 3-21)  <math>\Sigma Q_n = 21.5(4) = 30 \text{ k}</math> 3/4" <math>\Phi</math> Studs      5" rib <math>\rightarrow</math> strong position      deck <math>\perp</math>  <math>f'_c = 4000 \text{ psi}</math> (NWC)</p> <p><math>D_{eff} = \begin{cases} 30(2)/8 = 45" \\ \min \{ (4)(2)/2 = 36" \leftarrow \text{CONTROLS} \end{cases}</math></p> <p><math>a = \frac{\Sigma Q_n}{.85(f'_c)(b_{eff})} = \frac{30}{.85(4)(36)} = 2.5"</math>  <math>a/2 = \frac{2.5}{2} = 1.3"</math>  <math>7.5 - 1.3 = 6.2" = y_2</math></p> <p><math>y_1</math></p> <p><math>X = \frac{A_s F_y - \Sigma Q_n}{2(b_f)(F_y)} = \frac{(16.2)(50) - 30}{2(7.01)(50)} = .726 &gt; .505</math>      in WEB</p>	<p>LL=200 DL=180 <u>380</u></p> <p>(Note: No equipment called out in this area)</p> <p><math>W_u = 1.20 + 1.6L = 53 \text{ (psf (l))}</math>  <math>W_u = 3216 \text{ plf} = 3.2 \text{ klf}</math></p>  <p>3.2 klf</p> <p>48.2k</p> <p>V<sub>u</sub> (kips)</p> <p>48.2k</p> <p>361.8</p> <p>M<sub>u</sub> (kip-ft)</p> <p>14 shear studs</p> <p>14 shear studs</p> <p><math>V = \frac{wL}{2} = \frac{3.2(30)}{2} = 48.2</math></p> <p><math>M = \frac{wL^2}{8} = \frac{3.2(30)^2}{8} = 361.8 \text{ k}</math></p>

Table 3-19

Through Interpolation

$\gamma_2 = 6"$	$\gamma_1$	$\phi M_n$
	.505	910
		910
	3.46	840

$$\phi M_n = 912 \gg 362$$

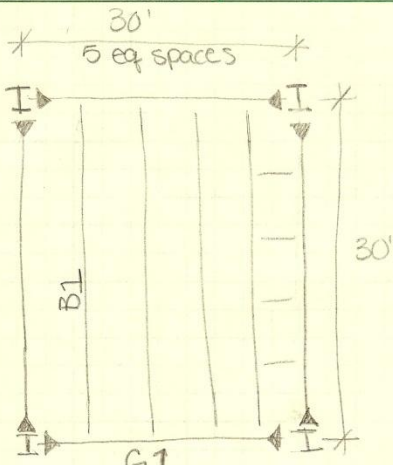
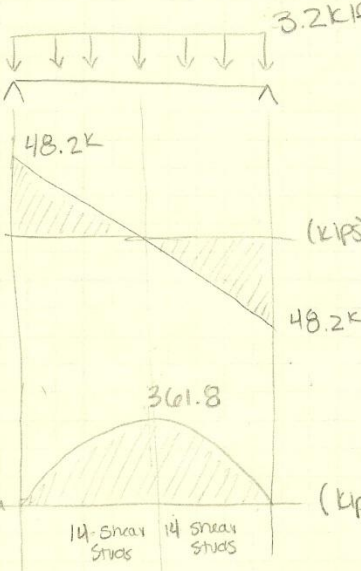
$$325.6/910 = \boxed{.36}$$

Way overdesigned!

My Design

$$\sum Q_n = 301$$

$$d_{eff} = 36$$

$$a = 2.8"$$

$$\gamma_2 = 6"$$

Table 3-19  $\Rightarrow$  TRY W16x31

$$\phi M_n = 393 > 362$$

$$\gamma_2 = 6"$$

$$\gamma_1 = .380$$

$$\Delta_u = 1/360 = \frac{30(12)}{360} = 1"$$

$$\Delta_u = \frac{5 w_u l^4}{384 EI_{cb}} = \frac{5(.2 \text{ ksf})(6')(30')^4 (1728)}{(384)(29000)(1040)} = .73" \checkmark \underline{OK}$$

3-0235 — 50 SHEETS — 5 SQUARES  
 3-0236 — 100 SHEETS — 5 SQUARES  
 3-0237 — 200 SHEETS — 5 SQUARES  
 3-0137 — 200 SHEETS — FILLER

COMET

## Girder Calculations

<p>Girder Check</p>		<p>Christina DiPaolo 1</p>
		$V = \frac{(3.2 \text{ klf})(30')}{2} = 48.2$ $V = \frac{(3.2 \text{ klf})(12')}{2} = 19.2$ $P_u = 48.2 + 19.2 = 67.4$
		$(67.4)4 / 30 = 8.99 \text{ klf}$
<p>Using ACI Moment coefficients for end span          ↳ span not equal use average  <math>l = 25'</math></p>		
$M^+ = \frac{w_u l_n^2}{11} = \frac{(8.99)(25)^2}{11} = 401.3 \text{ k}$ $M_{int}^- = \frac{w_u l_n^2}{10} = \frac{8.99(25)^2}{10} = -561.9 \text{ k}$ $M_{ext}^- = \frac{w_u l_n^2}{16} = \frac{8.99(25)^2}{16} = -351.2 \text{ k}$		
<p>UBL = 6'          try W21x68 @ 6'  <math>\phi M_n = 600 &gt; 561.9 \quad \checkmark \underline{\underline{OK}}</math></p>		
<p>or W24 for ease of construction          W24x68 @ 6'  <math>\phi M_n = 644 &gt; 561.9 \quad \checkmark \underline{\underline{OK}}</math></p>		
<p>They use W24x104 <math>\Rightarrow \phi M_n = 1080 \rightarrow</math> also part of the lateral system that will increase moments.</p>		



## Appendix H: Column Spot Check Calculation: Gravity System

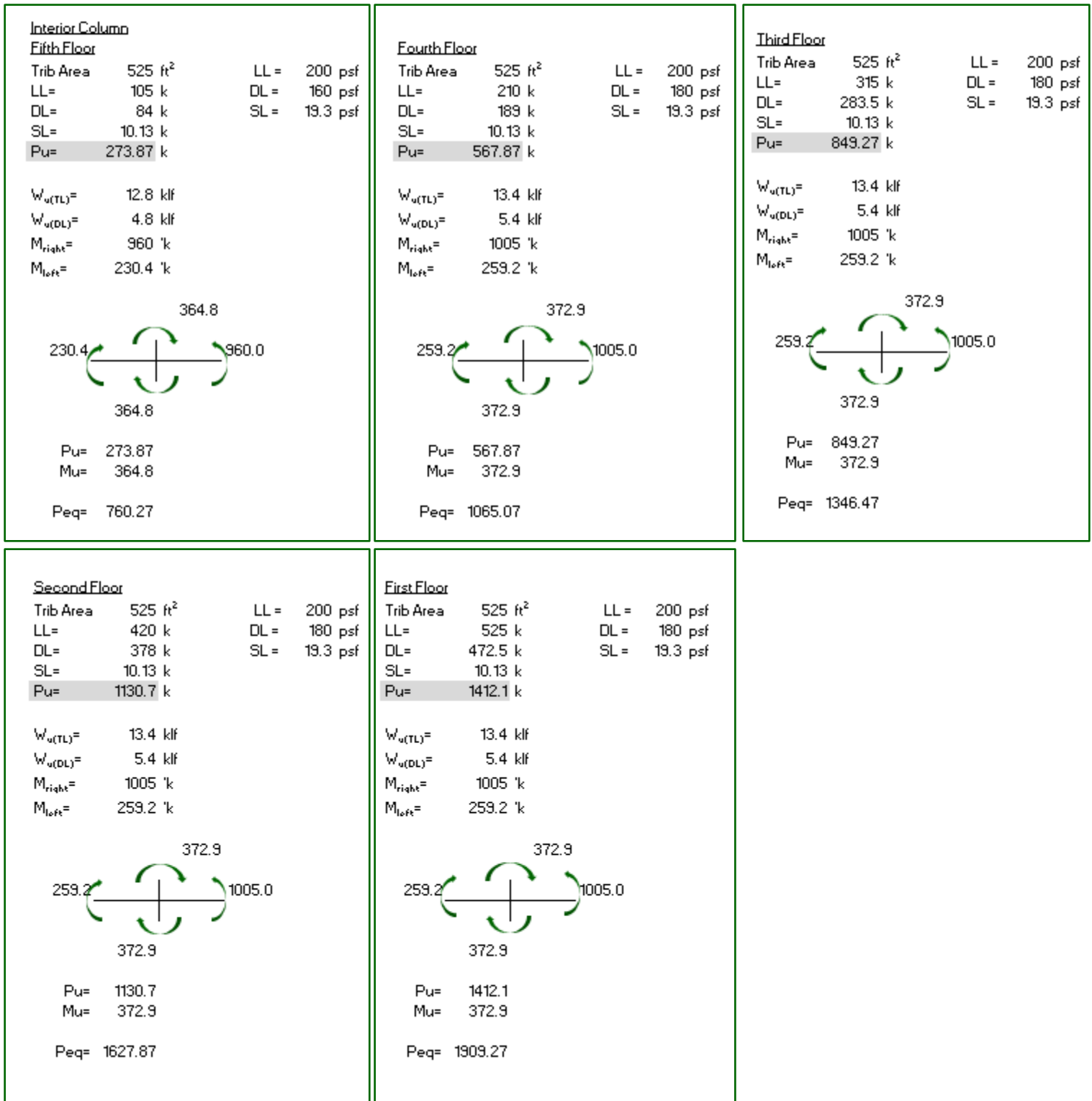

Figure H.1: The Excel calculations for unbalanced moment on the interior column per floor level.

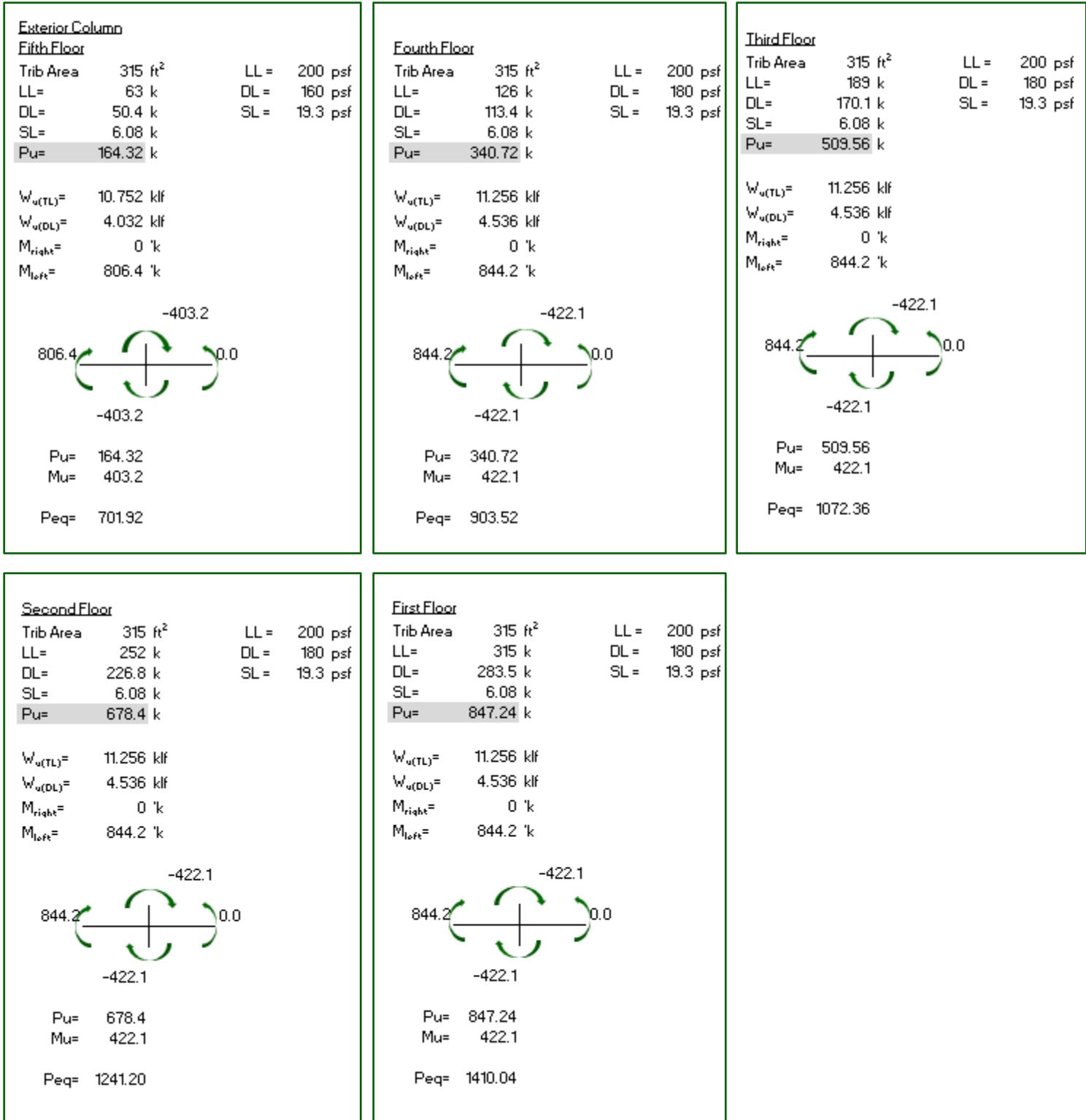
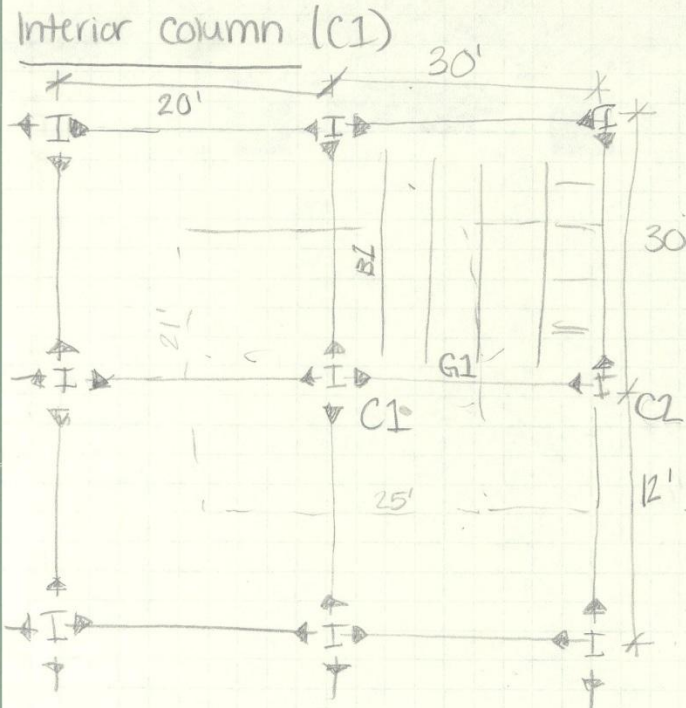

Figure H.2: The Excel calculations for unbalanced moment on the exterior column per floor level.

3-0235 — 50 SHEETS — 5 SQUARES  
3-0236 — 100 SHEETS — 5 SQUARES  
3-0237 — 200 SHEETS — 5 SQUARES  
3-0137 — 200 SHEETS — FILLER

COMET



Typical Floor Plan

$L = 200$   
 $D = 180$   
 Note: this area has no additional equipment loads  
 $A_e = \left(\frac{30}{2} + \frac{12}{2}\right) \times \left(\frac{30}{2} + \frac{20}{2}\right)$   
 $= 525$   
 LL NOT reducable  
 $L = 200 > 100$

\* All loads tabulated in excel

unbalanced moments (strong axis)

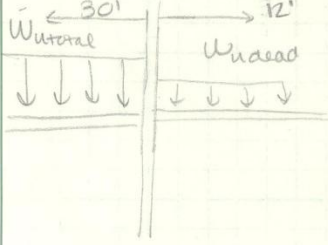

see table from excel

3-0235 — 50 SHEETS — 5 SQUARES  
 3-0236 — 100 SHEETS — 5 SQUARES  
 3-0237 — 200 SHEETS — 5 SQUARES  
 3-0137 — 200 SHEETS — FILLER

COMET

Column Check

Christina DiPaolo

2

Exterior column (C2)

$$A_+ = (15) \times \left( \frac{30}{2} + \frac{12}{2} \right) = 315$$

$$\text{trib width} = 15 + 6 = 21$$

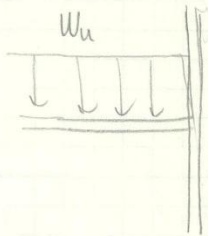

See table from excel

Both columns checked:

W14 x 370 for 1<sup>st</sup> floor + 2<sup>nd</sup> floor

↳ braced at floor levels ⇒ 24'

$$k = 1.0$$

$$\phi P_n = 3520^k > 1909^k \quad \underline{\underline{OK}}$$

Combo Loading

$$p = .284 \Rightarrow \phi P_n = 3520^k$$

$$p_y = .331 \Rightarrow \phi M_n = 3020^{1k}$$

$$\underline{\underline{INT}} \quad \Sigma M = \Sigma M_{\text{unbraced}} = 1856$$

$$\frac{P_r}{P_c} = \frac{1412}{3520} = .4 > .2$$

$$\frac{1412}{3520} + \frac{8}{9} \left( \frac{1856}{3020} \right) = .95 < 1.0$$

$$\underline{\underline{EXT}} \quad \Sigma M = 2091$$

$$\frac{P_r}{P_c} = \frac{847}{3520} = .24 > .2$$

$$\frac{847}{3520} + \frac{8}{9} \left( \frac{2091}{3020} \right) = .86 < 1.0$$

W14x116 for 3<sup>rd</sup> through 5<sup>th</sup> floor

↳ braced at floor levels  $\Rightarrow 18'$

$$K=1.0$$

$$\phi P_n = 3390^k > 1346^k \quad \checkmark \underline{\underline{OK}}$$

Combo loading

$$P = .295 \Rightarrow \phi P_n = 3390^k$$

$$b_x = .398 \Rightarrow \phi M_n = 2510^k$$

$$\underline{\text{INT}} \quad \Sigma M = \text{Mumbai } 3-5 = 1111$$

$$\frac{P_r}{P_c} = \frac{849}{3390} = .25 > .2$$

$$\frac{849}{3390} + \frac{8}{9} \left( \frac{1111}{2510} \right) = .64 < 1.0 \quad \checkmark \underline{\underline{OK}}$$

$$\underline{\text{EXT}} \quad \Sigma M = 1247$$

$$\frac{P_r}{P_c} = \frac{510}{3390} = .15 < .2$$

$$\frac{510}{2(3390)} + \left( \frac{1247}{2510} \right) = .57 < 1.0 \quad \checkmark \underline{\underline{OK}}$$

3-0235 — 50 SHEETS — 5 SQUARES  
3-0236 — 100 SHEETS — 5 SQUARES  
3-0237 — 200 SHEETS — 5 SQUARES  
3-0137 — 200 SHEETS — FILLER

COMET

## Appendix I: Non-Composite Steel System (Existing)

Noncomposite (Existing)	Christina DiPaolo	1
Noncomposite system - composite deck w/ concrete		
Typical Bay 3 <sup>rd</sup> Floor Floor Calcs		
	<p>Live Load = 200 Superimposed Dead Load = 98 <u>298 psf</u></p>	
<p><math>30/5 = 6' \Rightarrow</math> typical span worst span in building = 7'11" <math>\approx 300</math> psf <math>\approx 3'</math></p>	<p>Use 2VL118 w/ 6" NWC</p>	<p>2VL118</p>
<p>Unshored Length 3 span = 12'4" &gt; 6'</p>	<p>Note: largest span on building = 7'11" &lt; 12'4" <math>\checkmark</math> OK</p>	
<p>Live Load = 200 psf Super Imposed Dead = 98 psf Floor weight = 63 psf <u>361 psf</u></p>		
Beam Calcs		
	$W_u = [1.2(160) + 1.6(200)]/1000 = .513$	
	$.513(6') = 3.1 \text{ klf}$	
	$V_u = \frac{WL}{2} = \frac{(3.1)(30)}{2} = 46.5 \text{ k}$	
	$M_u = \frac{WL^2}{8} = \frac{(3.1)(30)^2}{8} = 349 \text{ k}$	
	$\Delta_u \leq 4/360$	
	$\Delta_u = \frac{5wL^4}{384EI} = \frac{5(1.2)(6)(30)^4 \times 1728}{384(29000)I} \leq \frac{(30)(12)}{360}$	
	$I \geq 754 \text{ in}^4$	

Non Composite (Existing)

Christina DiPaolo

2

$$\Delta_{TL} \leq L/240$$

$$\Delta_{TL} = \frac{5wL^4}{384EI} = \frac{5(3.6)(6)(30)^4 (1728)}{384(29000)I} \leq 30(12)/240$$

$$I \geq 907.5 \text{ in}^4$$

UBL = 0' (decking)

USE 21x50

$$\phi M_n = 413 > 349 \quad \checkmark \text{OK}$$

$$I = 984 > 908 \quad \checkmark \text{OK}$$

$$\phi V_n = 237 > 46.5 \quad \checkmark \text{OK}$$

Girder Check

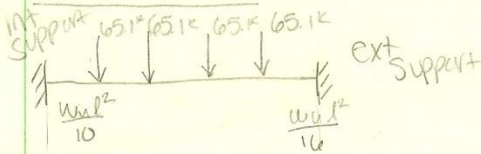

$$V = \frac{(3.1)(30)}{2} = 46.5$$

$$V = \frac{(3.1)(12)}{2} = 18.6$$

$$V_u = 46.5 + 18.6 = 65.1 \text{ k}$$

$$(65.1)4/30 = 8.68 \text{ klf}$$

Using ACI moment coefficients  
spans are not equal → use average

$$l = \frac{30 + 20}{2} = 25'$$

$$\text{pos moment} = \frac{w_u l^2}{14} = \frac{(8.68)(25)^2}{14} = 387.5 \text{ k}$$

$$\text{neg moment (ext support)} = \frac{w_u l^2}{16} = \frac{8.68(25)^2}{16} = -339.1 \text{ k}$$

$$\text{neg moment (int support)} = \frac{w_u l^2}{10} = \frac{8.68(25)^2}{10} = -542.5 \text{ k}$$

Deflection

$$\Delta_{LL} \leq L/360$$

$$w_L = 2(6) \left( \frac{30+12}{2} \right) (4)/30 = 3.36 \text{ klf}$$

$$\Delta_{LL} = \frac{(3.36)(30)^4 (1728)}{384(29000)I} = 1 \Rightarrow I \geq 422$$

Non Composite (Existing)

Christina DiPaolo

3

TRY W24x62

$$@ 6' \Rightarrow \phi M_n = 548'k > 542 \checkmark \underline{\underline{OK}}$$

$$I = 1550 > 422 \checkmark \underline{\underline{OK}}$$

Note: May need to be sized larger after lateral analysis

$$\Delta_{TL} = \frac{(3.38+2.7)(30)^4(1728)}{384(29000)(1550)} = .54 \text{ in}$$

$$\Delta_{TL} = \frac{(1.36)(5)(6)(30)^4(1728)}{384(29000)(984)} = 1.38 \text{ in}$$



## Appendix J: Composite Steel System

Composite Steel	Christina DiPaolo	1
<p>Composite System - composite deck w/ concrete</p> <p>Typical Bay 3<sup>rd</sup> Floor</p> <p>Live Load = 200 psf          Superimposed          Dead Load = 98 psf          298 psf</p> <p><math>30/5 = 6' \Rightarrow</math> typical span          see Noncomposite for floor calcs          use 2VL118 w/ 6" NWC</p> <p><u>Beam Calcs</u></p> <p><math>w_u = [1.2(161) + 1.6(200)] / 1000 = .513</math>  <math>.513(6') = 3.1 \text{ klf}</math>  <math>V_u = \frac{wL}{2} = \frac{(3.1)(30)}{2} = 46.5 \text{ k}</math>  <math>M_u = \frac{wL^2}{8} = \frac{(3.1)(30)^2}{8} = 349 \text{ k}</math></p> <p>Defl = <math>\frac{30(12)}{8} = 45''</math>          min <math>\frac{(6(12))}{2} = 36'' \leftarrow</math> controls</p> <p><math>\Delta_u \leq L/360 \Rightarrow I \geq 754 \text{ in}^4</math>  <math>\Delta_{TL} \leq L/240 \Rightarrow I \geq 907.5 \text{ in}^4</math></p>		

$$Q_n = 21.5^k$$

NWC

$$f'_c = 4 \text{ ksi}$$

1 string

$$1 \text{ stud/riv} \Rightarrow 2 \text{ studs/riv } Q_n = 14.6$$

$$3/4" \Phi$$

$$\Delta_{LLmax} = l/360 = 30(12)/360 = 1''$$

$$1'' = \frac{5[.2(6')](30')^4(1728)}{384(29000)I_{min}} \Rightarrow I \geq 754.1 \text{ in}^4$$

assume  $V_2 = 5.5 \text{ in}$ 

TRY W16x31

$$\phi M_n = 383 > 349 \text{ } \checkmark \text{ OK } I = 995 > 754.1 \text{ } \checkmark \text{ OK}$$

$$\Sigma Q_n = 274$$

$$274/21.5 = 12.7 \Rightarrow 13 \text{ studs } < 15 \text{ } \checkmark \text{ OK}$$

$$\text{economy } 31(30) + 26(10) = 1190$$

TRY W16x36

$$\phi M_n = 382 > 349 \text{ } \checkmark \text{ OK } I = 936 \text{ } \checkmark \text{ OK}$$

$$\Sigma Q_n = 181$$

$$181/21.5 = 8.4 \Rightarrow 9 \text{ studs } < 15 \text{ } \checkmark \text{ OK}$$

$$\text{economy } 36(30) + 18(10) = 1260$$

Wet concrete deflection

$$\Delta \leq l/240 = \frac{30(12)}{240} = 1.5''$$

$$\Delta = \frac{5(.003)(6')(30')^4(1728)}{384(29000)I} \Rightarrow I \geq 158.4$$

$$I_{W16x36} = 936 > 158 \text{ } \checkmark \text{ OK}$$

NO CAMBER

USE W16x31

## Girder Calcs

$$V = \frac{(3.1)(30')}{2} = 46.5$$

$$V = \frac{(3.1)(12)}{2} = 18.6$$

$$V_u = 46.5 + 18.6 = 65.1 \text{ k}$$

$$(65.1)4/30 = 8.68 \text{ klf}$$

same as noncomposite  $\Rightarrow$  use W 24x62

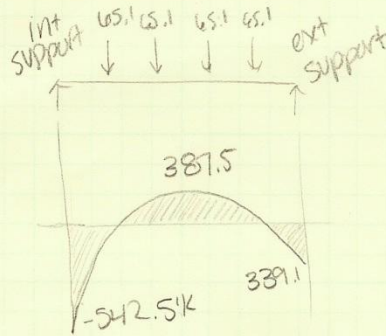

$$\Delta_{TL} = .54 \text{ in}$$

Gir

$$\Delta_{TL} = \frac{(361)(6)(5)(30^4)1728}{(384)(29000)995} = 1.37 \text{ in}$$

Beam

# Appendix K: Two-Way Flat Slab

Two Way - Flat Slab	Christina DiPaolo	1
	<p>30' x 24' BAY          24" sq columns          NWC  <math>f'_c = 4000 \text{ psi}</math>  <math>f_y = 60 \text{ ksi}</math></p> <p>NOTE: Changing column spacing for ease of construction + more uniform bays</p>	
<p>LOADS</p> <p>LL = 200 psf          SDL = 80 psf          * No additional point loads in this bay</p> <p>col = <math>\frac{24}{4} = 6'</math>          mid = <math>30 - (6)(2) = 18'</math></p>	<p>col = <math>\frac{24}{4} = 6'</math>          mid = <math>24 - (6)(2) = 12'</math></p>	
<p><math>h \geq \frac{l_n}{30} = \frac{(30'-2)'}{30} = 11.2' \Rightarrow 11'6" &gt; 5"</math>          (12')(150) / 12" = 150 psf</p>		

Direct Design Method $\geq 3$  spans in both directions  $\checkmark$ OK

$$\frac{l_1}{l_2} = \frac{30}{24} = 1.25 \checkmark$$
OK

successive span lengths  $\geq \frac{2}{3} l$   $20 = \frac{2}{3}(30) \checkmark$ OKno offsets  $\checkmark$ OK

all gravity

$$(144 + 80)2 = 422 > 200 \checkmark$$
OK

no beams

$$q_u = 1.2(150 + 80) + 1.6(200) = 589 \text{ psf}$$

Frame A: (Interior Bay)

$$M_o = \frac{.596(15)(22)^2}{8} = 534 \text{ k}$$

$$M^- = .65(534) = 347.1$$

$$M^+ = .35(534) = 186.9$$

Frame B: (Interior Bay)

$$M_o = \frac{.596(25)(22)^2}{8} = 891 \text{ k}$$

$$M^- = .65(891) = 579.2$$

$$M^+ = .35(891) = 311.9$$

Frame C: (Exterior Bay)

$$M_o = \frac{.596(25.75)(28)^2}{8} = 1486 \text{ k}$$

$$M_{int}^- = .70(1486) = 1040.2$$

$$M^+ = .52(1486) = 772.7$$

$$M_{ext}^- = .25(1486) = 371.5$$

Frame D: (Exterior Bay)

$$M_o = \frac{.596(24)(28)^2}{8} = 1385 \text{ k}$$

$$M_{int}^- = .70(1385) = 969.5$$

$$M^+ = .52(1385) = 720.2$$

$$M_{ext}^- = .25(1385) = 346.3$$

Factored Moment in column Strips/Middle Strips:

Frame A:

$$\frac{l_2}{l_1} = \frac{24}{15} = 1.6$$

$$\alpha_1 = 0$$

Negative  
75% goes to column strip  
ACI 13.6.4.1Positive  
60% goes to column strip  
ACI 13.6.4.4

$$CS_A^- = .75(347.1) = 260.3 \text{ k}$$

$$MS^- = .25(347.1) = 86.8 \text{ k}$$

$$CS_A^+ = .6(186.9) = 112.1 \text{ 'k}$$

$$MS_A^+ = .4(186.9) = 74.8 \text{ 'k}$$

Frame B:

$$\frac{l_2}{l_1} = \frac{24}{25} = .96$$

$$\alpha_1 = 0$$

Negative (ACI 13.6.4.1)  
75% to col strip

Positive (ACI 13.6.4.4)  
60% to col strip

$$CS_B^- = .75(579.2) = 434.4 \text{ 'k}$$

$$MS_B^- = .25(579.2) = 144.8 \text{ 'k}$$

$$CS_B^+ = .60(311.9) = 187.1 \text{ 'k}$$

$$MS_B^+ = .4(311.9) = 124.7 \text{ 'k}$$

Frame C:

$$\frac{l_2}{l_1} = \frac{25.75}{30} = .86$$

$$\alpha_1 = 0$$

$$b_1 = 0$$

Neg (int) (ACI 13.6.4.1)  
75% to col strip

Pos (ACI 13.6.4.4)  
60% to col strip

Neg (ext) (ACI 13.6.4.2)  
100% to col strip

$$CS_{Cint}^- = .75(1040.2) = 780.2 \text{ 'k}$$

$$MS_{Cint}^- = .25(1040.2) = 260.1 \text{ 'k}$$

$$CS_C^+ = .60(772.7) = 463.6 \text{ 'k}$$

$$MS_C^+ = .40(772.7) = 309.1 \text{ 'k}$$

$$CS_{Cext}^- = 371.5 \text{ 'k}$$

$$MS_{Cext}^- = 0 \text{ 'k}$$

Frame D:

$$\frac{l_2}{l_1} = \frac{24}{30} = .8$$

$$\alpha_1 = 0$$

$$a_1 = 0$$

Neg (int) ACI 13.6.4.1  
75% to col strip

Pos (ACI 13.6.4.4)  
60% to col strip

Neg (ext) (ACI 13.6.4.2)  
100% to col strip

$$CS_{Dint}^- = .75(969.5) = 727.1 \text{ 'k}$$

$$MS_{Dint}^- = .25(969.5) = 242.4 \text{ 'k}$$

$$CS_D^+ = .6(720.2) = 432.1 \text{ 'k}$$

$$MS_D^+ = .4(720.2) = 288.1 \text{ 'k}$$

$$CS_{Dext}^- = 346.3 \text{ 'k}$$

$$MS_{Dext}^- = 0 \text{ 'k}$$

For Reinforcement see EXCEL tables  $\Rightarrow$  use #5 bars

Effective depth

FRAMES C & D span the longer distance  $\rightarrow$  bottom reinforcement

$$d_{eff_{co}} = 12 - .75 - \frac{.75}{2} = 10.875 \Rightarrow \text{in drop panels}$$

$$d = 10.875 + 4.25 = 15.125$$

$$d_{eff_{rs}} = 10.875 - .75 = 10.125$$

Amount of reinforcing needed exceeds allowable levels  $\rightarrow$  add drop panels

### Wide Beam Action

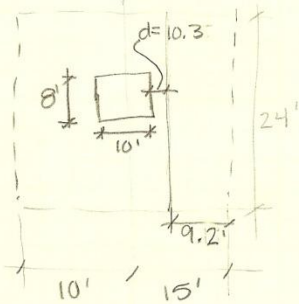

$$d_{avg} = \frac{10.75 + 9.85}{2} = 10.3$$

$$V_u = w_u \times 9.2' \times 24' \\ = (596)(9.2)(24) = 131.6 \text{ k}$$

$$V_n = V_c = 2\sqrt{f'_c} b_w d \\ = \frac{2\sqrt{4000} (24 \times 12)(10.3)}{1000} \\ = 373.4 \text{ k}$$

$$\phi V_n = .75(373.4) = 281.4 \text{ k} > 131.6 \text{ k} \quad \checkmark \underline{OK}$$

### Two Way Action - Punching Shear

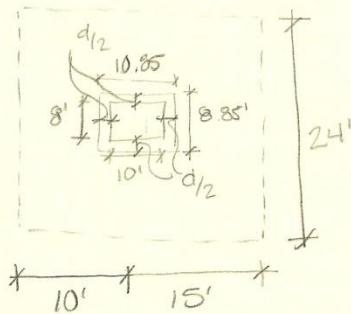

NOTE: Ignoring the weight of the drop panel because it only adds loads to the system.

$$V_u = w_u \cdot \text{area} \\ = 596 [(24)(25) - (8.85)(10.85)] \\ = 300.4 \text{ k}$$

$$\beta_c = \frac{b_e}{b_s} = \frac{24''}{24''} = 1 < 2 \Rightarrow V_c = 4\sqrt{f'_c} b_w d$$

$$\phi V_c = 4\sqrt{f'_c} b_w d = 4\sqrt{4000} (39.4)(12)(10.25) = 919.5 \text{ k} > 300 \text{ k} \quad \checkmark \underline{OK}$$

$$b_w = 2(8.85) + 2(10.85) = 39.4'$$

Frame A (Interior Bay)				
Description	Column Strip		Middle Strip	
	M <sup>-</sup>	M <sup>+</sup>	M <sup>-</sup>	M <sup>+</sup>
Moment, Mu (k*ft)	260.3	112.1	86.8	74.8
Width of Strip, b (in.)	72	72	108	108
Effective Depth, d (in.)	10.125	10.125	10.125	10.125
Mn = Mu/φ = Mu/0.9 (k*ft)	289.2	124.6	96.4	83.1
R = Mn/bd <sup>2</sup>	470.2	202.5	104.5	90.1
ρ <sub>req'd</sub> (from Tbl A.5a)	0.0085	0.0035	0.0018	0.0015
A <sub>s</sub> = ρ*b*d (in <sup>2</sup> )	6.1965	2.5515	1.9683	1.64025
A <sub>smin</sub> = 0.0018*b*t	1.0368	1.0368	1.5552	1.5552
N = (Larger of A <sub>s</sub> and A <sub>smin</sub> )/0.44	<b>15</b>	<b>6</b>	5	4
N <sub>min</sub> = Width of Strip / 2t	3	3	<b>5</b>	<b>5</b>
N <sub>max</sub> : From ρ <sub>max</sub> = 0.0206 (Tbl A.4)	35	35	52	52

Frame B (Interior Bay)				
Description	Column Strip		Middle Strip	
	M <sup>-</sup>	M <sup>+</sup>	M <sup>-</sup>	M <sup>+</sup>
Moment, Mu (k*ft)	434.4	187.1	144.8	124.7
Width of Strip, b (in.)	72	72	108	108
Effective Depth, d (in.)	10.125	10.125	10.125	10.125
Mn = Mu/φ = Mu/0.9 (k*ft)	482.7	207.9	160.9	138.6
R = Mn/bd <sup>2</sup>	784.7	338.0	174.4	150.2
ρ <sub>req'd</sub> (from Tbl A.5a)	0.0151	0.0068	0.003	0.0022
A <sub>s</sub> = ρ*b*d (in <sup>2</sup> )	11.0079	4.9572	3.2805	2.4057
A <sub>smin</sub> = 0.0018*b*t	1.0368	1.0368	1.5552	1.5552
N = (Larger of A <sub>s</sub> and A <sub>smin</sub> )/0.44	<b>26</b>	<b>12</b>	<b>8</b>	<b>6</b>
N <sub>min</sub> = Width of Strip / 2t	3	3	5	5
N <sub>max</sub> : From ρ <sub>max</sub> = 0.0206 (Tbl A.4)	35	35	52	52

Frame C (Exterior Bay)						
Description	Column Strip			Middle Strip		
	M <sup>-</sup> <sub>ext</sub>	M <sup>+</sup>	M <sup>-</sup> <sub>int</sub>	M <sup>-</sup> <sub>ext</sub>	M <sup>+</sup>	M <sup>-</sup> <sub>int</sub>
Moment, Mu (k*ft)	371.5	463.6	780.2	0	309.1	260.1
Width of Strip, b (in.)	72	72	72	72	72	72
Effective Depth, d (in.)	15.125	10.875	15.125	10.875	10.875	10.875
Mn = Mu/φ = Mu/0.9 (k*ft)	412.8	515.1	866.9	0	343.4	289.0
R = Mn/bd <sup>2</sup>	300.7	725.9	631.6	0	484.0	407.3
ρ <sub>req'd</sub> (from Tbl A.5a)	0.0053	0.0141	0.0118	0	0.0089	0.0073
A <sub>s</sub> = ρ*b*d (in <sup>2</sup> )	5.7717	11.0403	12.8502	0	6.9687	5.7159
A <sub>smin</sub> = 0.0018*b*t	1.0368	1.0368	1.0368	1.0368	1.0368	1.0368
N = (Larger of A <sub>s</sub> and A <sub>smin</sub> )/0.44	<b>14</b>	<b>26</b>	<b>30</b>	<b>3</b>	<b>16</b>	<b>13</b>
N <sub>min</sub> = Width of Strip / 2t	3	3	3	3	3	3
N <sub>max</sub> : From ρ <sub>max</sub> = 0.0206 (Tbl A.4)	51	37	51	37	37	37

Frame D (Exterior Bay)						
Description	Column Strip			Middle Strip		
	M <sup>-</sup> <sub>ext</sub>	M <sup>+</sup>	M <sup>-</sup> <sub>int</sub>	M <sup>-</sup> <sub>ext</sub>	M <sup>+</sup>	M <sup>-</sup> <sub>int</sub>
Moment, Mu (k*ft)	346.3	432.1	727.1	0	288.1	242.4
Width of Strip, b (in.)	72	72	72	72	72	72
Effective Depth, d (in.)	15.125	10.875	15.125	10.875	10.875	10.875
Mn = Mu/φ = Mu/0.9 (k*ft)	384.8	480.1	807.9	0	320.1	269.3
R = Mn/bd <sup>2</sup>	280.3	676.6	588.6	0	451.1	379.6
ρ <sub>req'd</sub> (from Tbl A.5a)	0.0049	0.0127	0.0109	0	0.0081	0.0067
A <sub>s</sub> = ρ*b*d (in <sup>2</sup> )	5.3361	9.9441	11.8701	0	6.3423	5.2461
A <sub>smin</sub> = 0.0018*b*t	1.0368	1.0368	1.0368	1.0368	1.0368	1.0368
N = (Larger of A <sub>s</sub> and A <sub>smin</sub> )/0.44	<b>13</b>	<b>23</b>	<b>27</b>	<b>3</b>	<b>15</b>	<b>12</b>
N <sub>min</sub> = Width of Strip / 2t	3	3	3	3	3	3
N <sub>max</sub> : From ρ <sub>max</sub> = 0.0206 (Tbl A.4)	51	37	51	37	37	37

Figure K.1: The Excel calculations for minimum reinforcement in the column strips and middle strips for Frames A through D

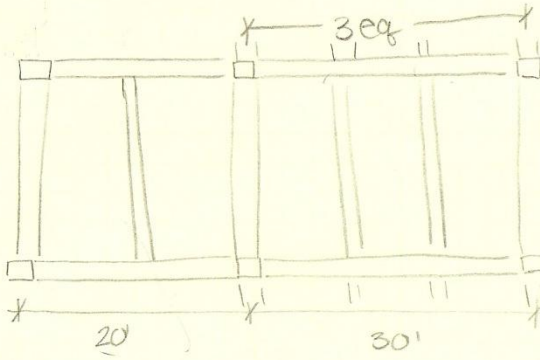
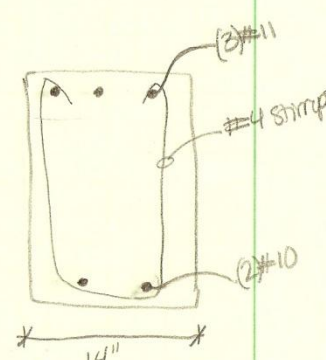

## Appendix L: One-Way Concrete Slab

One Way Slab	Christina DiPaolo	1
 <p> <math display="block">h_{min} = l/24 = \frac{10(12)}{24} = 5"</math> </p> <p>From CRSI Table:</p> <ul style="list-style-type: none"> <li><math>f'_c = 4000 \text{ psi}</math></li> <li><math>f_y = 60 \text{ ksi}</math></li> <li><math>W_u = 1.2(80) + 1.6(200) = 416 \text{ psf}</math></li> </ul> <p>Use 6" slab</p> <ul style="list-style-type: none"> <li>#5 @ 12" o.c. bottom bars p.a.005</li> <li>#4 @ 12" o.c. bottom bars</li> <li>#3 @ 10" o.c. T-S bars</li> <li>@ 10' span <math>\Rightarrow 435 \text{ psf} &gt; 416 \text{ psf}</math> <u>OK</u></li> </ul> <p><u>Beam</u></p> <p> <math display="block">h_{min} = l/18.5 = \frac{24(12)}{18.5} = 15.6 \Rightarrow 16"</math> </p> <p> <math display="block">W_u = 1.2D + 1.6L = 1.2(80 + 75) + 1.6(200) = .506 \text{ ksf}</math> </p> <p> <math display="block">W_u = .506 \text{ ksf} (10') = 5.06 \text{ kF}</math> </p> <p>Use <math>h = 20</math>  <math>b = 14</math></p> <ul style="list-style-type: none"> <li>2 #10 on bottom</li> <li>3 #11 on top</li> </ul> <p>STIR 10 #4 <math>\Rightarrow</math>      10 #4      1 @ 2", 15 @ 8" each side</p> <p>Defl <math>\Rightarrow C = 530E-9</math></p> <p> <math display="block">\Delta = C \times \left(\frac{W}{1.4}\right) \times l_n^4 = 530 \left(\frac{5.06}{1.4}\right) (22.3')^4 = .47"</math> </p>	<p>             Note: 3 equal spans of 10' to take advantage of same formwork as rest of building.         </p> <p> <math>l_n = 24 - 20/12 = 22.3'</math> </p> <p> <math>LL = 200 \text{ psf}</math>  <math>SDL = 80 \text{ psf}</math>  <math>slab = \frac{(6") (150)}{12} = 75 \text{ psf}</math> </p> 	

Girder

$b = 14$

$l_n = 30 - 14/2 = 28.8$

$V = \frac{5.06 \times 28.8}{2} = 57.68 \text{ k}$

$(57.68)4/30 = 7.69 \text{ klf}$

$h = 28$

$b = 20$

top = 2#10 full length

2#10 .875  $l_n$ 

4#14

Stirrups 165  $\text{ft} \Rightarrow 16 \#5$  stirrups

1@ 2"

5@ 8"

10@ 11"

Defl  $\Rightarrow C = 153 \times 10^{-9}$ 

$$\Delta = 153 \times 10^{-9} \left( \frac{7.69}{1.4} \right) (28.8)^4 = .51''$$

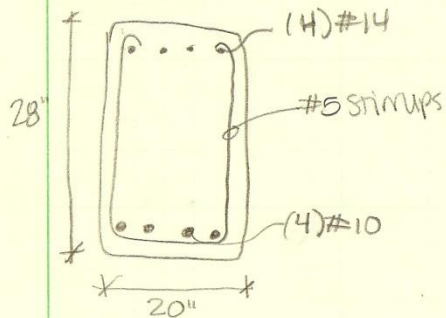

## Appendix M: Load Distribution Calculations

Frame Relative Stiffness			
North-South Dir		East-West Dir	
Frame 1	3	Frame A	17.6
Frame 2	12.08	Frame B	20.0
Frame 3	14.29	Frame C	20.9
Frame 4	14.38	Frame D.1	2.7
Frame 5	14.47	Frame D	17.8
Frame 6	20.8	Frame E	11.0
Frame 7	21	Frame F	10.1
Σ=	100.0 %	Σ=	100.1 %

Figure L.1: The Excel calculations for relative stiffness of the moment frames.

Center of Mass					
Mass	Area	Length <sub>x</sub>	A*L <sub>x</sub>	Length <sub>y</sub>	A*L <sub>y</sub>
A	487.5	6.25	3047	49.5	24131.3
B	7920	67.5	534600	36	285120
C	1500	107.5	161250	97	145500
Σ	9907.5	Σ	698897	Σ	454751
		CM <sub>x</sub>	70.5	CM <sub>y</sub>	45.9
		CM <sub>xETABS</sub>	70.5	CM <sub>yETABS</sub>	45.9

Figure L.2: The Excel calculations for the center of mass of the first floor through the roof.

Center of Rigidity							
Frame	Rigidity	Length <sub>y</sub>	R <sub>j</sub> Y <sub>j</sub>	Frame	Rigidity	Length <sub>x</sub>	R <sub>i</sub> X <sub>i</sub>
A	17.6	0	0	1	3.00	0	0
B	20.0	30	600	2	12.08	12.5	151
C	20.9	42	876	3	14.29	32.5	464
D.1	2.7	69	188	4	14.38	52.5	755
D	17.8	72	1282	5	14.47	72.5	1049
E	11.0	99.5	1094	6	20.80	92.5	1924
F	10.1	122	1232	7	20.97	122.5	2569
		Σ	5271			Σ	6912
		CR <sub>y</sub>	52.7			CR <sub>x</sub>	69.1
		CR <sub>yETABS</sub>	51.6			CR <sub>xETABS</sub>	69.3

Figure L.3: The Excel calculations for the center of rigidity.

LOAD DISTRIBUTION								
Frame	Rigidity	di (ft)	J = kd <sup>2</sup>	kd	Direct Loads X	Direct Loads Y	Torsional Loads X	Torsional Loads Y
Frame 1	3.0	69.1	14324	207.3	0.03 P	0 P	0.00621 Pe <sub>x</sub>	0.00591 Pe <sub>y</sub>
Frame 2	12.1	56.6	38699	683.728	0.1208 P	0 P	0.02049 Pe <sub>x</sub>	0.01949 Pe <sub>y</sub>
Frame 3	14.3	32.5	15094	464.425	0.1429 P	0 P	0.01392 Pe <sub>x</sub>	0.01324 Pe <sub>y</sub>
Frame 4	14.4	16.6	3963	238.708	0.1438 P	0 P	0.00715 Pe <sub>x</sub>	0.00680 Pe <sub>y</sub>
Frame 5	14.5	3.4	167	49.198	0.1447 P	0 P	0.00147 Pe <sub>x</sub>	0.00140 Pe <sub>y</sub>
Frame 6	20.8	23.4	11389	486.72	0.208 P	0 P	0.01458 Pe <sub>x</sub>	0.01387 Pe <sub>y</sub>
Frame 7	21.0	53.4	59883	1121.4	0.21 P	0 P	0.03360 Pe <sub>x</sub>	0.03196 Pe <sub>y</sub>
Frame A	17.6	52.7	48880	927.52	0 P	0.176 P	0.02779 Pe <sub>x</sub>	0.02643 Pe <sub>y</sub>
Frame B	20.0	22.7	10303	453.8638	0 P	0.19994 P	0.01360 Pe <sub>x</sub>	0.01293 Pe <sub>y</sub>
Frame C	20.9	10.7	2388	223.202	0 P	0.2086 P	0.00669 Pe <sub>x</sub>	0.00636 Pe <sub>y</sub>
Frame D.1	2.7	16.3	723	44.336	0 P	0.0272 P	0.00133 Pe <sub>x</sub>	0.00126 Pe <sub>y</sub>
Frame D	17.8	19.3	6630	343.54	0 P	0.178 P	0.01029 Pe <sub>x</sub>	0.00979 Pe <sub>y</sub>
Frame E	11.0	46.8	24071	514.332	0 P	0.1099 P	0.01541 Pe <sub>x</sub>	0.01466 Pe <sub>y</sub>
Frame F	10.1	69.3	48505	699.93	0 P	0.101 P	0.02097 Pe <sub>x</sub>	0.01995 Pe <sub>y</sub>
Σ=			285019					

Figure L.3: The Excel calculations for the center of rigidity.

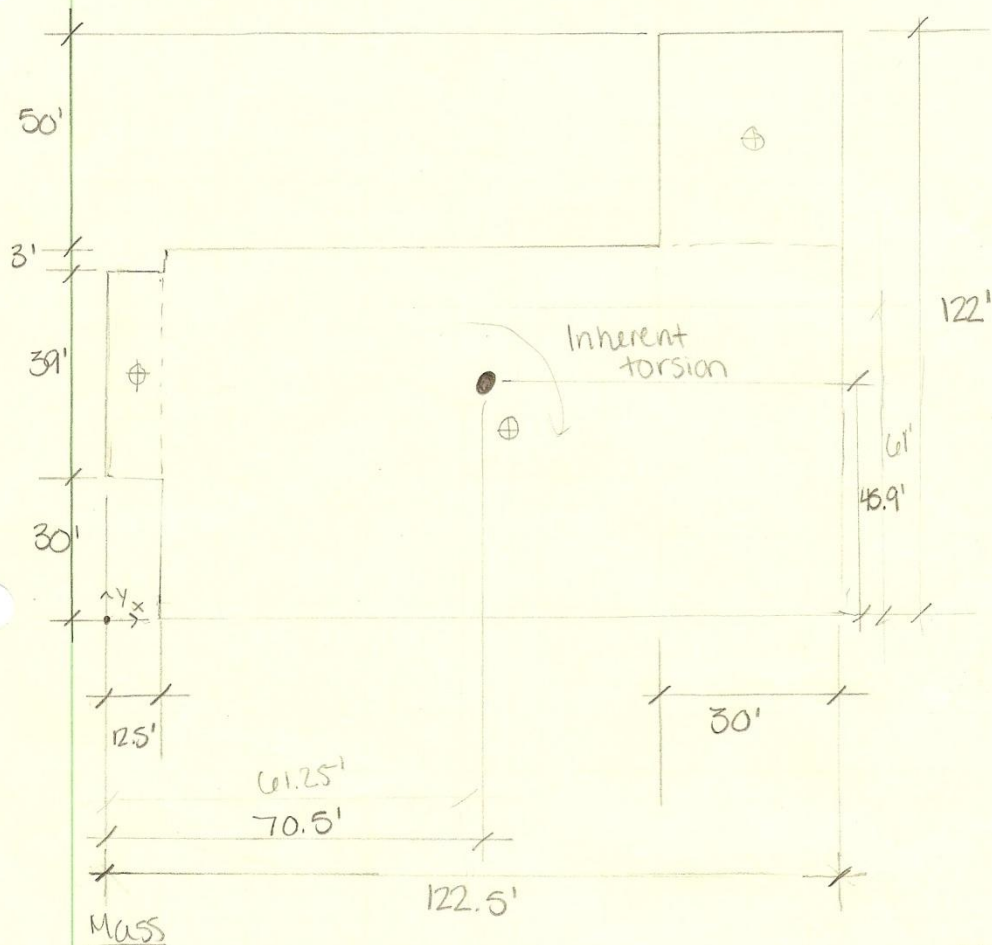
center of mass/rigidityMass

$$CM_x = \frac{(12.5)(39)(\frac{12.5}{2}) + (110)(72)(\frac{110}{2} + 12.5) + (30)(50)(\frac{30}{2} + 92.5)}{(12.5)(39) + (110)(72) + (30)(50)}$$

$$= 70.5'$$

$$CM_y = 45.9'$$

Rigidity

$$CR_x = \frac{R_i X_i}{R_i} = 69.1$$

$$CR_y = 43.6$$

## Appendix N: Column Spot Check Calculations: Lateral System

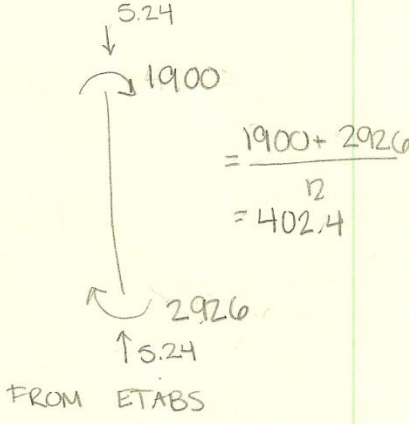
Column Spot Checks	Christina DiPaolo	1
<p><u>Interior Column</u></p> <p>From gravity checks</p> <p><math>P_u = 1412.1</math> <math>M_u = 372.9</math></p> <p>Total Load</p> <p><math>P_u = 5.24 + 1412.1 = 1417.3</math> <math>M_u = 1856.4 + 402.2(.5) = 2057.5</math></p> <p><math>\frac{P_r}{P_c} &gt; .2</math></p> <p><math>\frac{1417.3}{3520} + \frac{8}{9} \left( \frac{2057.5}{3020} \right) = 1.0 = 1.0 \checkmark \underline{OK}</math></p>		
<p><u>Exterior Column</u></p> <p>From gravity checks</p> <p><math>P_u = 847.2</math> <math>M_u = 2091.6</math></p> <p>Total Load</p> <p><math>P_u = 38.5 + 847.2 = 885.7</math> <math>M_u = 337.3 + 2091.6 = 2428.9</math></p> <p><math>\frac{P_r}{P_c} &gt; .2</math></p> <p><math>\frac{885.7}{3520} + \frac{8}{9} \left( \frac{2428.9}{3020} \right) = .91 &lt; 1.0 \checkmark \underline{OK}</math></p>	